

Periphery syndrome — a reinterpretation of regional development theory in a resource periphery

MARKKU TYKKYLÄINEN



Markku Tykkyläinen (1988). Periphery syndrome — a reinterpretation of regional development theory in a resource periphery. *Fennia* 166: 2, pp. 295—411. Helsinki. ISSN 0015—0010.

A study is made of industrialization and the transition in economic structure as it has affected a remote peripheral region of Finland with a predominantly resource-based economy over the last twenty years or so. The empirical results are used to interpret and develop theory of regional development adequate for describing the transition of this peripheral region from an area dominated by primary-sector production to one characterized by industry and the service sector. The resource-based peripheral region concerned is the province of Northern Karelia.

A region-level core-periphery system is outlined in which the organization of the economy, the division of labour, performance potential and environmental relations are examined by regional and spatial analysis and resource analysis. A model is developed for evaluating the performance potential of an economy and proposing alternative paths of development.

Development in a periphery is regulated by external impulses (demand, regional policy, etc.) together with the distinctive features imposed on the economy by its past history. This development can be explained by reference to rationalization in resource processing sectors, profitability difficulties, poor growth propensity and special characteristics of the division of labour and the adoption of new technology. The combined effect of these factors, termed here the periphery syndrome, leads to differences in affluence and in general to regional differentiation in the economy. The syndrome is dynamic in nature. The principal problems following the economic transition are shifting away from rationalization in agriculture and towards the structure of industry itself. The resource periphery is becoming an industrial periphery.

The conclusions comprise a set of eight conceptual systems of factors which should be taken into account when studying economic transition and industrialization in peripheral regions. These concern development with respect to population, rationalization, regional policy, the spatial division of labour, spatial cost structures, demand, entrepreneurship and resource and environment factors and the influence of these on regional development in the periphery in question.

The differences in development between the sectors of industry are of significance for regional development as a whole, and allowance should be made for these in the theory. Where theories of development in resource peripheries tend to represent outcomes of a number of external and internal factors and ones applying to individual sectors, the explanatory model evolved here comprises theoretical concepts of a number of different types.

Markku Tykkyläinen, University of Joensuu, Department of Geography, P.O. Box 111, SF-80101 Joensuu, Finland. MS. received 25th September, 1987 (revised 17th May, 1988).

Introduction	296	Orientation and starting-points for the re-	
Aims and structure of the research	296	search	299
The region studied	297	Resources	301
Resources and regional development	299	The environment and regional development	303
		Core-periphery relations in a regional system	309

Core-periphery structure and natural resources	313	Use of natural resources and development of the peripheral economy	380
Structure of production and control functions	313	Significance of resource-based industry	380
Changes in industry and employment in Northern Karelia	318	The transition of the 1960's and 1970's	381
The resource base: stocks, flows and utilization	323	Resource processing, new industries and core functions	385
Materials flow analysis	326	Growth and development	387
Resources and waste in a peripheral production system	328	A discussion on further development	391
Resources in relation to exports, local consumption and investment	336	Transition in a periphery — a framework for further development	391
Materials and energy flows in the production system	340	International competition and continuation of the transition	392
Revising the economic structure of a resource periphery	346	Conclusions	394
Seeking alternatives	346	Theoretical observations — applicability of the theory to a resource periphery	394
The evaluation method	348	Methodology	396
Characteristics of the economy of Northern Karelia	353	Acknowledgements	397
A profitability-based alternative	357	References	397
A resource-processing alternative	359	Appendices	404
Fictive growth — up to the year 2000	362		
Subjective evaluation	366		
Comparison of the alternatives	378		
Optimization, subjective evaluation and the economy of Northern Karelia	379		

Introduction

Aims and structure of the research

The development regions of Finland have been subject to far-reaching changes since the mid-1960's, involving population migration, a decline in primary sector labour requirements and industrialization. These development regions, comprising the central and northern parts of the country, have traditionally been suppliers of food-stuffs, timber and mining products, with other forms of industry rather poorly represented. If we are to attempt to understand matters of economic development in these regions and evaluate their future prospects, we inevitably require research data regarding the particular nature of industrial production devoted to the exploitation of local natural resources and the economic transition as it affects regions heavily dominated by the primary sector. This is obvious, since the primary sector and first-degree manufacturing based on its products form the backbone of the economic structure in such regions and since the

many structural problems affecting the economy are focused very largely on these functions.

The aim of this present work is to ascertain what are the characteristic features of resource exploitation in a peripheral economy of the kind practised in Northern Karelia and examine how the transition in the regional economy is linked with natural resources, employment levels and the effects of industry on the environment. At a more general level, the problem can be summed up in the question of how development has been and is being realized in this resource-based periphery, with what consequences, and what kind of reinterpretation of the theories of regional and spatial development is needed. Resource exploitation and other aspects of the economy differ in such areas from the models elaborated for core areas. What implications do these features have for the development of peripheral economies? What future is in store from the point of view of the exploitation of natural resources and the preservation of the environment? These are the questions which have prompted this research, alongside specific points connected with the development of the region concerned here.

Use will be made here of the terminology familiar from core-periphery research, also known among economic geographers as the heartland-hinterland paradigm (Berry et al. 1976). Although this terminology functions on several areal levels, we will confine ourselves here to problems at the regional level. It has also proved necessary to fill in this paradigm, especially with reference to the exploitation of natural resources and environmental effects by introducing elements known in geographical circles under the heading of resource analysis and management. The dynamics of a peripheral economy, its economic transition, is linked here with the examination of core-periphery relations as a whole, while the normative questions that are raised contain a certain spin-off from regional science and planning, in which the closest bases for the quantitative models used here are to be found.

The present work consists of seven chapters. The remaining part of this introduction comprises a description of the region concerned, the second chapter examines approaches to research into regional development as a geographical problem and discusses theories connected with this research, its concluding parts being devoted to problems in the fields of the exploitation of natural resources and the spatial division of labour (cf. the section "Core-periphery relations"). Core-periphery relations are presented in the form of a hypothetical model in which weight is placed on the exploitation of natural resources in peripheral areas, loading of the environment and the spatial division of labour, and the structure and transition implied by the model are studied empirically in stages.

The third chapter contains an analysis of the production systems associated with core and peripheral areas and the dependency relations obtaining between the economy and the natural environment in the study area, suitable methods being developed for the analysis of these aspects. The instruments for accomplishing this include materials flow analysis, which enables the relations between resource use and the generation of waste to be studied, and also the distribution of these two functions between exported and local use.

Problems and evaluation principles concerned with changes in a peripheral economy, i.e. growth and development, are discussed at the beginning of the fourth chapter, and problems forming the basis for the evaluation are defined more precisely and an examination is made of trends in industry. An evaluation schema comprising a linear

programming model and a simulation model is then used to study alternative economic structures and resource use and loading of the environment caused by these. At the same time the viewpoint of the examination is extended to include questions of the viability of a peripheral economy, its division of labour, etc. Structural alternatives are produced in two ways: 1) by optimizing the production structure of the economy according to given criteria, and 2) by subjective evaluation. In the latter case two target groups are used for presenting the economic development alternatives.

The evaluation model enables different types of economic structure alternatives to be generated, and also allows a counterfactual situation to be created for the evaluation of economic structures. The criteria for the alternatives are maximal viability and full utilization of the region's resources with current technology. An attempt is made to bring out the limits of the economic structure alternatives and the implications they carry with them. How and on what conditions can one, or could one, develop the economy of a peripheral area? The viewpoint of the evaluation is broadened from that provided by the purely numerical results obtained from the model by employing subjective evaluation by two groups of people, one composed of students and the other of businessmen. Two types of alternative are obtained in this way, the first based on optimization and the second on some kind of satisfaction criterion (Chadwick 1971: 301—319). The results obtained by these different approaches are then compared.

The various directions of development available for a peripheral economy are distinguished in the fifth chapter, while the sixth concentrates on the limitations to peripheral development and the challenges posed for it by international trends. The seventh chapter is a discussion of the results and evaluation of the methods used.

The region studied

The region studied here as an example of a peripheral economy is that of Northern Karelia, the easternmost province of Finland, located 400—500 km north-east of the capital, Helsinki, which is part of the province of Uusimaa (Fig. 1). Comparative data, where required, are taken from the country as a whole, the province of Uusimaa and the Helsinki conurbation.

Northern Karelia had a total of 177,206 inhabitants in December 1982, an average of 8 per sq.

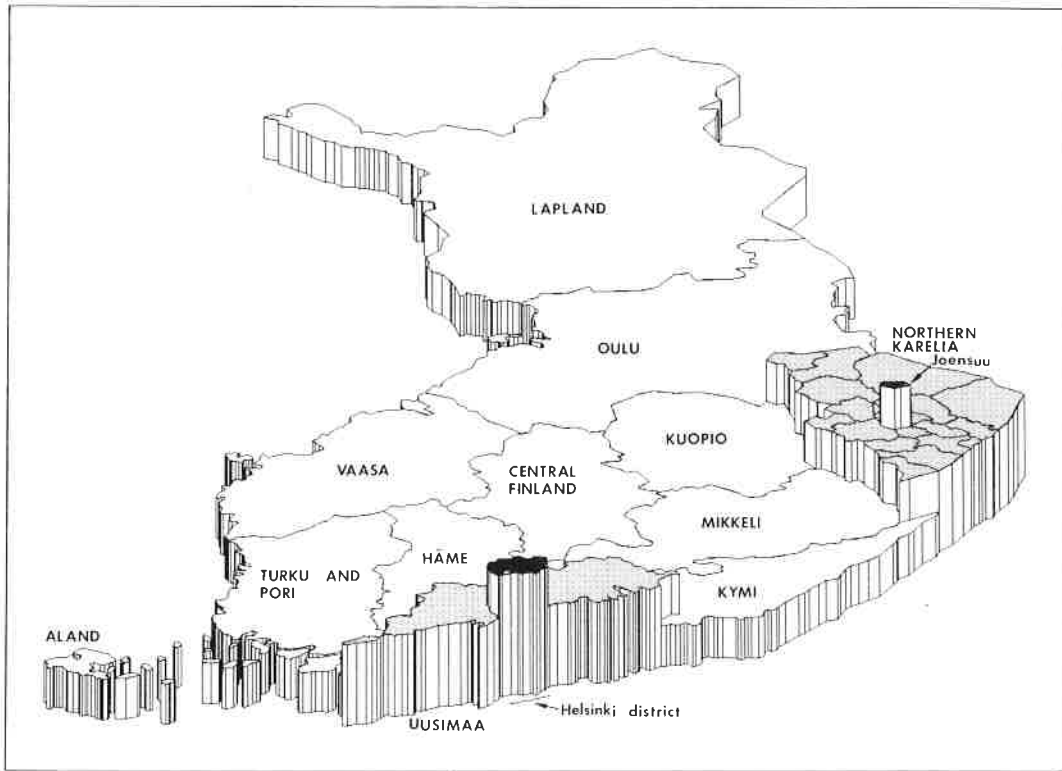

Fig. 1. The region studied, Northern Karelia, and Uusimaa and the provinces of Finland.

km., and accounted for 3.7% of the population of Finland as a whole (STV 1983). It is an area which has suffered from severe problems of economic structure and unemployment over the last twenty years or so, and very large amounts of labour have been released from the primary sector. The population of the region was still increasing sharply in the 1950's, but after that a decline set in, and the outmigration trend of the 1960's gave the area a negative population balance. This migration, which reached its culmination around 1970, was directed chiefly towards Southern Finland. Only Joensuu, the largest town in the region, was able to increase its population throughout the migration wave of the 1960's and 1970's (Vartiainen 1979: 26—39).

Migration slowed down and became more even in the early 1970's, but unemployment increased. By Nordic standards, Northern Karelia is one of the worst areas for unemployment (Fig. 2). Admittedly figures have increased more in relative terms in Southern Finland and in the urban areas in recent years than in the development regions

and the country districts (Katajamäki 1984), but the rate of unemployment in Northern Karelia is still substantially higher than in the developed parts of the country (Fig. 2).

A division of Finland into a developed region and a development region may be made along provincial boundaries, assigning the provinces of Uusimaa, Häme, Turku and Pori and Kymi to the developed part, which includes Helsinki, the capital and the country's administrative and commercial centre, located in the province of Uusimaa (Fig. 1). The development region is then left to comprise the provinces of Mikkeli, Northern Karelia, Kuopio, Central Finland, Vaasa, Oulu and Lapland, and also the Åland Islands, a province with certain rights of self-government. The official division of the country for the purposes of regional policy during the period 1966—75 followed these same broad outlines, although more recently the less developed areas within the southern provinces have also qualified for some regional policy benefits.

Northern Karelia emerges as the poorest de-

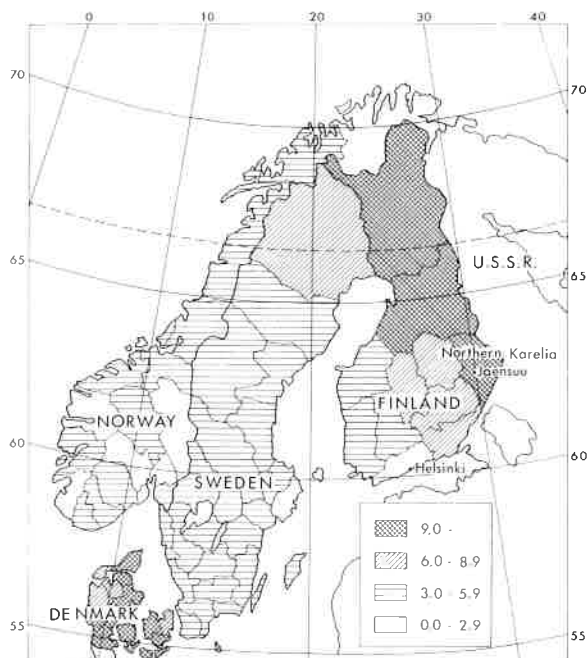

Fig. 2. Unemployment percentages for the provinces of Finland and the other Nordic countries in August/September 1984 (Regional utveckling ... 1984: 9).

veloped part of Finland on very many criteria. This can be seen in its standard of living and in structural factors (Alueellinen kehittyneisyys 1979). Although many reports claim that the differences were reduced in the 1960's and 1970's (see Alueellinen kehittyneisyys 1979; Palomäki 1980), regional differences in development at the provincial level are still high in Finland by general European standards and virtually comparable with those prevailing in southern Europe (Kiljunen 1979: 85).

Along with an evening out of the differences in regional levels of development, a tendency can also be perceived for the problems of development to become more complicated. The difficulties associated with the quality of life in largish towns are a reality in Finland, as in other countries (Kuitunen & Siirilä 1984: 3—7), but they are mainly confined to Helsinki and the larger cities elsewhere in the country.

The results obtained with measures such as regional self-sufficiency, exports from a region, etc. are dependent on the areal unit employed, which should be a functional and administrative entity in order to provide a comprehensive pic-

ture of the economic system operating within it. The present region, Northern Karelia, is defined in accordance with the administrative provincial boundary, which like all such boundaries is a conventional one, although influenced by economic considerations. Sphere of influence studies suggest that the province forms a fairly clear-cut entity given its present boundaries (LTT 1967; Pohjois-Karjalan seutukaavaliitto 1982; Palomäki 1968).

Functionality also implies an areal hierarchy, however, with centres and their spheres of influence at different levels, and generalizations concerning provinces, conurbations, development regions, etc. inevitably interpret this hierarchical reality in a generalized manner and from the point of view of a particular areal level. In the present case, the intermediate-level administrative divisions fit in well with the provincial boundaries. Northern Karelia is a historical province, "maakunta", with boundaries that are also those of an administrative province, "lääni". It is also a planning region, with both regional planning boundaries and provincial planning boundaries following the same pattern, this planning being directed primarily at public administration and the development of the infrastructure. Good justification for the use of Northern Karelia as an areal unit for the present purposes is thus to be found within both administrative systems of regions and systems arising from the study of spheres of influence.

Resources and regional development

Orientation and starting-points for the research

Regional development can be understood in terms of qualitative and quantitative changes in a regional economy, or in a spatial economic system in the broader sense, implying changes in the occupational and areal structure. Regional development may be generated by economic, social and cultural innovations (Hermansen 1972: 6—7), which achieve various outcomes, favourable or unfavourable, according to one's set of values (Brookfield 1975: xi). The term economic transition is employed to refer to the sequence in regional development in which the regional

economy adapts to the conditions imposed by the economy at large (i.e. to changes in demand or restrictions on the supply of natural resources) by means of structural changes. Industrialization and the rationalization of primary production in the development regions are major features of this transition in Finland.

The functioning of the regional economic system is an interactive entity which gives expression to economic, social, spatial and environmental interaction relationships. The topic of the present work is the primary production-dominated periphery, and the aim is to test the viewpoint which regards economic transition as one aspect of core-periphery interaction. This dominant role of the primary sector and the associated developmental problems favour the inclusion of questions of natural resources and the environment when studying this regional system. Such regional systems are studied by many other sciences as well as geography, e.g. regional science, regional economics, or ecology, and each attempts to emphasize viewpoints and weightings derived from its own paradigms. In the case of geography it is spatial relationships that are uppermost when looking at economic interactions. The spatial and economic viewpoints have also been combined in some regional development models (see Berry et al. 1976; Palomäki 1972), but it is equally the case that the interaction between socio-economic systems and physical systems forms a major topic of geographical investigation (Chorley 1973; Anuchin 1973; Hustich 1975), and thus geography all told offers a relatively wide perspective for studying regional development.

Of the various fields of geography, regional development has traditionally been a topic of study within human and planning geography. Attention has been paid to regional changes in employment, changes in the regional division of labour, location factors, the location of centres of economic activity, trade flows to and from hierarchies of centres, etc. At the same time, to use the division into fields of geography which is generally accepted in Finland, the study of natural resources and environmental effects can be assigned either to physical geography or to human or planning geography depending on the particular emphasis one chooses to give to the research problem. Branches of science in themselves should not impose restrictions on research, however, even though regional development and the effects it implies as far as the physical environment is concerned can be regarded as a

functionally strictly delimited research topic.

The present accent on development in a peripheral region, the structural properties of the local economy and the connections between industrial production and the physical environment also leads us to examine those economic processes which play a crucial role in a region dominated by primary sector production. The adaptation of the regional economy of this peripheral area to general economic trends has meant a reduction in the primary sector labour force and a shift towards industry. The distinctive features of the exploitation of natural resources and manufacturing based on this gain expression within regional development and are thus in an important position as regards any transition in such a peripheral economy.

The emphasis laid upon the utilization of natural resources in the periphery arises for a number of reasons. Firstly, a predominantly primary sector economy is more explicitly linked in its functions to the natural resource base of its region than is any other type of economy, and secondly, the exploitation of natural resources affects the characteristics and development of a peripheral economy. Thirdly, the use of natural raw materials and the existence of manufacturing industry based on these affects the natural environment of peripheral areas, and fourthly, the uncertainty factors associated with the availability and pricing of natural raw materials have increased the importance of such factors for industrial policy and regional development planning. Fifthly, environmental considerations have been raised as one criterion when considering industrial development. Environmental problems arise to a significant extent in connection with the processing industries, the type most frequently involved when one is concerned with manufacturing based on natural raw materials. These factors all serve to justify the assumption that the exploitation of natural resources plays a major part in development in peripheral areas.

The concept of resources has a wide variety of meanings in common parlance depending on the context in which it is used. It may be understood in the sense of economic resources, for instance, natural resources, labour resources, etc., and it is also frequently used in a very general sense to mean something that can be exploited. In a geographical connection it is often taken to refer automatically to natural resources. This aspect is covered in the review of trends in Finnish geography by Yli-Jokipii (1982) under the heading of inventories of natural resources, and mention is

made among the most recent work in the field of the research of Kontturi (1980) into the utilization of esker material. In the end, research into the exploitation of natural resources may be assigned to very many branches, chiefly that of economic geography (Yli-Jokipii 1982: 132—135), in which case it taken to include agriculture (Varjo 1980, 1976; Talman 1978) and forestry (Häkikilä 1980, 1977), both of which make implicit reference to resource questions. In the present paper resources will be viewed primarily as comprising natural resources, labour and capital, particular attention being paid to the first two of these.

Resources

”The totality of our living can be divided into matter, energy and information” (Boulding 1966). Energy and matter are convertable, while information assumes concrete form in both of these. The parts of these categories that are usable from a human point of view may be deemed resources, which may be divided into human, cultural and natural resources (Whitaker 1954) (Fig. 3). A division of resources into categories of this kind is relatively common, in fact, so that Sant (1982: 43), for example, distinguishes 1) natural resources, 2) man-made capital, and 3) human resources. The operational equivalents of the concepts of resource vary with time and place at least to some extent. We will look here at the traditional conceptual content of labour and capital. Capital may be taken to include machinery, equipment and buildings required for production purposes, while labour is measured in terms of the number of persons participating in this production. The operational content of the concept of natural resources is less well established, however, and it is this that requires closer examination here. As Zimmermann (1951) infers, ”Natural resources are that part of matter, energy and information in the physical environment which is useful for man, and the rest is ’neutral stuff’”. Natural resources form a culturally bound concept that is dependent on the extent to which matter, energy and information can be made use of. Thus the recognition of a certain element as a natural resource requires the existence of the necessary information for exploiting it and the perception of the exploitation as something useful (cf. Simmons 1974: 42).

The use made of natural resources depends on man’s biological and cultural needs and his ca-

	Matter	Energy	Information
Natural resources	"usable" material	energy flows, energy engaged to materials	genetic information
Human resources	individuals	human work	skills, knowledge
Cultural resources	builded & man-made environment		cultural heritage, social & technolog. institutions

Fig. 3. Matter, energy and information in a resource context.

capacity for exploiting these resources (Fig. 4). Man employs his technological and organizational skills in order to appropriate natural resources for his use, but this activity is restricted by ecological barriers (resistances), and its nature and extent are governed in the last resort by questions of supply and demand.

Cultural advances have rendered certain natural resources more necessary than others. Some have fallen out of use, and others have come in their place. Machines and the technology required for building them have increased in importance over the centuries, and human labour has been progressively replaced by the use of machinery and energy. At the same time, mankind has become ever more dependent on human and cultural resources.

The principles of resource use may be summed up in three factors, 1) changes in what man needs, 2) changes in sources of supply, and 3) changes in what man can find a use for (Paterson 1978: 6—7). Any examination of resources is therefore bound to a given place and a given stage in social development. Resources are concretized in the form of the benefits they bring to man, natural resources, labour and capital bringing benefit within an industrial system in terms of the consumer commodities which they can be used to produce. When examined in the long term, benefit as a qualitative and quantitative measure of resources, and especially natural resources, can

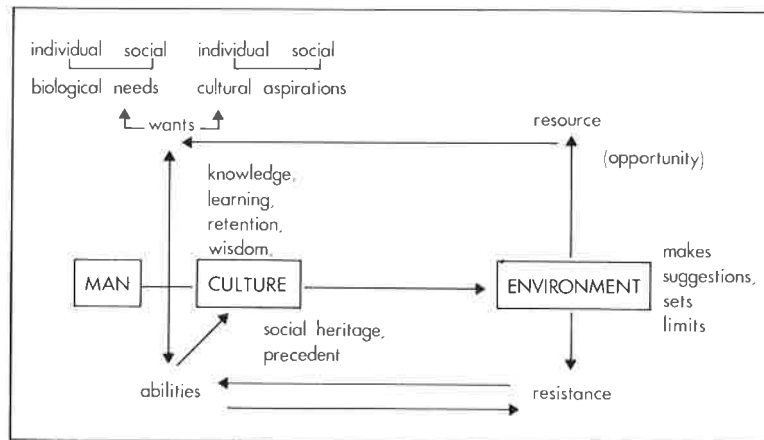

Fig. 4. Resources and human needs (O'Riordan 1971: 5).

only be identified (and operationalized) to a limited extent by means of a valuation in terms of market prices. Prices describe the balance between supply and demand at a given moment in the utilization of resources, but it is difficult to use such values to describe future use, resource potential or the like, because price relations alter with technological advances and changes in consumer demand. Account can be taken of potential or zero-priced natural resources in such an evaluation in physical terms, although again the figures referring to the future have important conditions attached to them (e.g. they are dependent on changes in relative prices and technological advances).

The next chapter will be devoted principally to natural resources, while labour and capital will be discussed in Chapter "Revising . . .". For our purposes, the concept of natural resources can be interpreted "in a broad sense that implies those aspects of the environment that possess potential for development and exploitation for man's assumed benefit. Such benefits may be seen at times as strictly economic ones, but the questions of social and cultural benefits are now also considered; moreover, the time scale of benefit realization is no longer merely short or medium term but may extend far into the future" (Gregory 1974: 373). The future is dependent on the choices and decisions continually being made by man in his actions, and is thus composed of a set of choices and opportunities. As soon as the study of resources is extended into the future, the resources to be used have a certain probability of being resources, with an element of uncer-

tainty attached to the question of their exploitation.

Natural resources are usually classified according to their renewal ability, renewable resources often being referred to as flow resources and non-renewable ones as stock resources (Ciriacy-Wantrup 1952: 42—43). Renewable resources can also be divided into flow and continuous categories, where the former denote ones whose renewal can be regulated by man and the latter ones whose nature and amount are more or less beyond human control (Johnston 1983: 137). The renewability of natural resources affects the conditions which need to be placed on their exploitation and the consequences that will arise from this exploitation (Lecomber 1978: 36—54).

Natural resources constitute an input factor in the process of the economic use of materials and energy, a process which transforms these input factors into benefits, only to return them to natural processes again eventually in the form of waste (Georgescu-Roegen 1971), i.e. production processes have the effect of changing natural resources into commodities and waste, with the aid of other natural resources. These commodities are then consumed, and finally all the natural resources end up as waste. The generation of waste is usually undesirable as far as the environment is concerned, and this places restrictions on the use of natural resources. Various means are available for reducing and restricting the inconveniences posed by waste, e.g. improved production technology and waste recycling to lessen the proportion of natural resources used and waste generated in relation to the goods produced. Such

changes in production processes frequently mean alterations in the proportions of goods produced in different regions and changes in the environmental effects and their distribution, etc., and in this way are reflected in matters of regional development.

The environment and regional development

Environmental exploitation and the spatial division of labour

The human ecology view of the relationship between welfare and development takes into account population, the utilization of natural resources and environmental loading. In terms of the global economy, material wealth is dependent on resources and the intensity of their exploitation, the size and structure of the population sharing the resulting commodities and the loading imposed on the environment (see Miller 1979). These concepts of human ecology become still more complex when one is dealing with an areal system. Demand determines what is produced and consumed in the area, and material affluence is to a great extent dependent on the available machinery and technology, trade with other areas and the exchange rates employed in this trade. At the regional level the areal unit is also dependent on the central government and its economic and regional policies, etc. External dependence relations usually become increasingly more important the smaller the areal unit considered is.

Among the factors affecting exploitation of the environment, i.e. utilization of its natural resources and environmental loading, are considerations of demand and the ensuing extent and structure of production, and also norms and systems of values related to the quality of the environment and the preferred time-scale for its exploitation, the opportunities which the environment offers for exploitation, the sensitivity with which it reacts to such interventions and the time-lag of any such reactions. The more the industrial structure of a given area is biased toward one field, the more production is geared to the exchange of goods and a regional division of labour. The importance of factors affecting loading of the environment depends on the properties of the area in question. The principal consideration in a town is the consumption level of the community, which determines the potential loading to be imposed on the environment, while

loading in industrial areas is governed by the structural features of the industries concerned. The products generated in country areas, on the other hand, are largely derived from natural resources, which will have an immediate impact on the environment, especially a local impact, usually as a consequence of resource utilization. The sensitivity of the environment to activities of this kind is dependent on physical conditions, in other words, on how the damage to the environment is repaired. Norms and systems of values set limits to the use made of the environment and the loading imposed on it, in the last resort at the stage where the environmental effects are becoming overtly detrimental to man. It depends on the economic and social system as to what extent one can influence the general conditions imposed on resource utilization and environmental exploitation at different areal levels.

The spatial division of labour has traditionally taken the form of sectoral spatial specialization, which is evident in terms of differences in the structure of production from one area to another. Areas dominated by primary production produce raw materials both for their own use and for that of industrial and urbanized areas, while services and industrial products are the prerogative of the urban and industrial areas, from where they are also made available to meet the needs of the primary production areas (Clapham 1981: 27—34). Many primary production areas nowadays are undergoing major structural changes, however, including industrialization, and sectoral spatial specialization is losing currency as a division of labour to the binary dimension industrial area vs. agricultural area. In the same way the traditional sectoral division of labour in industry is being eroded (Massey 1979), to be replaced by new forms of spatial division of labour. This intrasectoral division of labour implies that routine production in a given field is consigned to areas just undergoing industrialization, while the functions involving a high degree of specialized processing are located in the true industrial and urban areas. The division into fields of industry is also cross-cut by intra-firm divisions of labour in which functions within the one company, especially head office and factory floor functions, are split up geographically. All these forms of division of labour are subsumed in the structure of production.

The structure of production and the changes in demand which affect it will have direct repercussions for the extent of production, the utilization of natural resources and loading of the en-

vironment. Alongside market forces, society attempts to control in various ways what products are generated and what processes are employed for this purpose, and developmental trends in the spatial division of labour, being one part of the structure of production, serve in turn to govern the spatial distribution of the exploitation of natural resources and loading of the environment, in the present case their distribution between regions or places.

A society naturally changes its values in the course of time, however, and alterations in demand and advances in technology also reshape the system of industrial production. These factors are also reflected in the utilization of natural resources, of course, and on the impact on the environment. The principles of environmental exploitation can be grouped into five stages of development within a society (Miller 1979: 22—29), of which the last three are relevant to development in a primary production-dominated periphery undergoing industrialization. These three stages interpret the relationship between man and nature in the following ways: a) the Agricultural Society: humans against nature, more control over nature, with increased undesirable local and regional environmental effects, b) the Industrial Society: humans against nature, much more control over nature with more and more undesirable local, regional and global environmental effects, and c) the Earthmanship Society: humans and nature, selective control based on ecological understanding and global cooperation with nature to reduce undesirable environmental effects. This theory may be examined from the viewpoint of the utilization of natural resources and its environmental effects. The values we have acquired and the technology we have developed affect the use we make of natural resources and the production achieved, and in this way these, too, have regional effects. It is also interesting in the light of this scheme of developmental stages to consider how natural resources are linked with development in different areas of the economy and how their exploitation and the resulting environmental loading change in character with structural changes in different regions and branches of industry. How are these changes reflected in regional development? It would seem that features of the system of regions must introduce their own specifications into this, while advances in systems of production must introduce strata of different types into the system of regions with respect to exploitation of the environment.

Theories of regional development

There are many theories concerned with regional development, but none has been fully confirmed and can thus explain development itself. The spatial implications of these theories are largely contradictory (e.g. cumulative causation theories vs. neoclassical theories of development) and they place differing emphasis on the subject matter (e.g. the theory of comparative advantage, the theory of polarized growth, the growth pole theory and the central place theory). In many cases their perspective on resource use and environmental effects as one aspect of economic development and growth is restricted. The general equilibrium theories draw attention mainly to the location of resources, transportation costs and the optimal allocation of production (see Weber 1929; von Thünen 1966; Lösch 1954; Christaller 1966; Isard 1956). The assumptions made by such theories are somewhat narrow compared with the complexity of the problem in reality, and they usually concentrate on describing a state of equilibrium. Their assumptions then serve to explain a limited part of the behaviour of human activity, usually being content to define the optimal behaviour under a given set of initial premises.

Theories concerned with the location of industry and land use focus attention on plant-specific economic variables (see Smith 1981: 45—348). The classical location theories discuss the optimal location of production chiefly as a function of the transportation costs attached to the raw materials and finished products, and the location of services and branches of production requiring little in the way of raw materials is explained by means of central place theories. Theories of land use have been used to explain development in rural areas (see Barlowe 1978: 275—286), while theories based on the optimal utilization of resources are aspatial in character and normally deal with the exploitation of a given reserve or supply of some resource by given techniques (see Lecomber 1978). All these as such have only partial applications to regional development as a complex, multi-sectoral process.

Although general economic growth is based on increased productivity, this is not sufficient to explain regional differences. Some specification is needed of how a general economic change is transposed into regional development. Regional development is frequently approached in terms of a separate theory of economic growth, regional growth theory, based on economic pro-

gress made in one growth centre, growth area or other limited spatial entity (Smith 1981: 400—410; Richardson 1977).

Export-based theories of regional economics assume growth to be derived from external demand stimuli, which generate growth in the whole regional economy by a multiplier effect. This implies that growth is dependent to a great extent upon trends in the demand for export items, and if demand declines the same chain-reactions lead to a recession in the whole regional economy. The transmission of growth is dependent on the nature of the regional economy, however, and is linked with the structure of production, technology and infrastructure. Since these factors differ spatially, e.g. on the core-periphery axis, development can be manifested in many ways within a system of regions.

Many theories of regional development focus attention chiefly on economic interactions, the advantages of an agglomeration and innovations (see Brookfield 1975; Hermansen 1972). Interaction relations, or interpreted more narrowly, multiplier effects, give rise to cumulative growth, or trickling-down (spread) effects. Urbanization and the spatial hierarchy of centres are usually regarded as mediatory factors in this development. These theoretical constructs are of importance especially for the arguments and measures associated with regional policy, the trickling-down effect, for instance, being seen as the basis for the creation of growth centres and the alleviation of polarization effects in underdeveloped or recession-stricken areas.

These growth and recession effects are often treated as one factor affecting the development of a system of regions (Myrdal 1957; Friedmann 1973; Pred 1965; Perroux 1970; Boudeville 1966; Hirschman 1958; Berry et al. 1976). For a critique, see Hansen (1981). A separate group of theories consists of the structural imbalance models (see Frank 1969; Holland 1976), which emphasize the dependence of economic development upon the economic and social structure of the prevailing social order.

Growth in terms of multiplier effect models and models based on the advantages of agglomeration and the development of infrastructures can be achieved only when production costs can be pushed lower in the periphery than in the developed areas (see Smith 1981: 167—190). This then diverts investment to the peripheral areas because these offer prospects of higher capital returns. Companies' costs are also bound to their location, and both their returns and costs are affect-

ed by the opportunities offered by the industrial environment around them, which affect raw material prices, wages and capital expenditure. The environment in development regions differs from that in industrialized areas, at least with respect to service functions, communication facilities and costs, the availability of skilled labour, the purchasing and transportation of goods and the accessibility of commercial services, and industrialization in the development regions may be seen as a consequence of more favourable costs levels in these respects. This still does not provide adequate conditions for regional growth, however, for a demand for goods is also needed for industrial production to exist at all.

In the case of many products closely associated with primary production, e.g. foodstuffs and products of the wood processing industries, demand increases only very slowly and production and local manufacture based on this is restricted by the degree to which the natural resources in question can be exploited. Thus, now that rationalization has reduced the labour engaged in agriculture in particular, the crucial question for economic transition in areas previously dominated by the primary sector is to what extent industrialization can succeed in compensating for the reduction in labour in the primary sector and with what consequences. Many expanding branches of industry, e.g. the clothing industry, the manufacture of metal products, etc., are not limited in location by raw material considerations, however, and the use made of capital and energy, together with the effect on employment, is structurally sector-specific in different fields. Thus development is sectorally asymmetrical, which means that developmental factors have to be distinguished for each sector separately in the case of a peripheral economy, while still taking account of the structure of the spatial system.

Resource research in relation to regional development

The idealized models lying behind the research are diverse (see Radnitzky 1970; Harvey 1969; Holt-Jensen 1981), and the choice of methodology needs to be made on the basis of the problem to be solved, so that the concepts and procedures used will be appropriate to this particular problem. But how can resources be discussed in research into regional development, and particularly core-periphery relations?

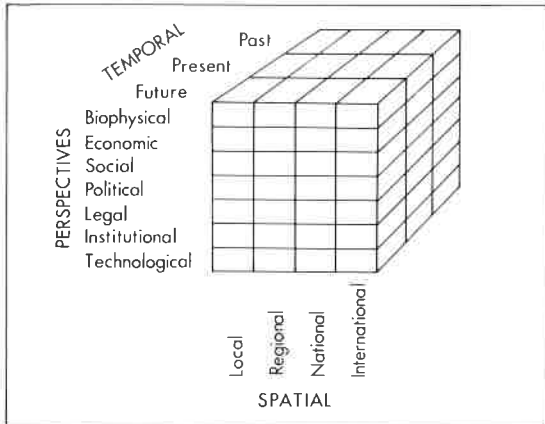

Fig. 5. Dimensions of resource research in geography (Mitchell 1979: 6).

Mitchell (1979) lays stress on a diversity of approaches in the study of resources, so that, in accordance with Krueger & Mitchell (1977) we can look at them from several different angles on both the temporal and the spatial dimension (Fig. 5). As Mitchell (1979: 6) states: "analysis of resource problems may be pursued through one or more of these perspectives. If temporal and spatial components are added, a matrix is created which emphasizes the importance of achieving in-depth knowledge about specific perspectives, time periods and spatial scales, as well as an appreciation of their interaction."

The conceptual, temporal and spatial dimensions of resource research are described here in matrix form (Fig. 5). The conceptual dimension ('perspectives') includes nature and different forms of human activity, defining at the same time the various branches of geography implicated, while the temporal and spatial dimensions indicate the association of this research with processes taking place in time and space. The weight attached to these dimensions depends on the nature of the problem to be examined. In the present case we will restrict our discussion to the economic perspective and the regional level. In temporal terms the work covers a span from the recent past into the near future.

It is the resource management approach that has been able to highlight perhaps most clearly the complex interrelations between the factors involved in the man vs. nature confrontation, although it has had practically nothing to say about regional development as such. Birch

(1973), in his discussion of the problem of resource management within geography, stresses research into spatial, ecological and institutional relations as an important area for geographers. He does not see these as distinct questions, but notes: "Indeed, it could be argued that a major role of geography in resource management is to ensure the appropriate spatial dimension and accuracy in ecological analysis in order to achieve understanding at the scale of the regional system" (Birch 1973: 6). Understood in a broad sense, Birch is emphasizing the same areas of responsibility as Mitchell, even though management refers more explicitly to areal planning than does resource research, since it links a process or substance with the spatial dimension.

A corresponding distinction is made by Chapman (1976: 15) in his discussion of the resource situation in Canada. He recognizes functional, spatial and institutional dimensions. The functional dimension corresponds to Birch's ecological dimension, but its content is stated to be "the facts of production, processing and consumption, which in turn relate to such elements as productive capacity, efficiencies of conversion, price fluctuation, market demands and social perceptions and preferences" (Chapman 1976: 15). The functional dimension thus incorporates the study of the processes contained in the economy, which may seem to be divorced entirely from the ecological theme if the latter is treated in its narrow sense. Economic activity nevertheless consists of the production of goods, and this is linked directly to the processes of nature via the utilization of sources of energy and raw materials and the disposal of the ensuing waste. Thus the ecological and functional dimensions are not opposed one to the other but complementary, representing differences in emphasis with regard to the same substance.

It would seem most apt for the present purposes to interpret the ecological, functional and institutional dimensions as referring to research into resource-related processes in the regional economy, covering the perspectives delimited in Fig. 5 insofar as these impinge upon regional development. This establishes resource use and environmental effects as factors contributing to regional development and connects them with changes in the properties of the regional economy, i.e. changes in technology, economic structure and growth.

Coppock and Sewell (1975: 5—7) in conformity with Fig. 5, also recognize four spatial levels, and note that the spatial dimension in geography

is largely weighted in favour of the regional level (Coppock & Sewell 1975: 6), as is understandable in view of the science's 'regional' tradition. A spatial orientation also implies the need to study the relations between areal levels, which is particularly apposite when attempting to understand the functioning of open regional production systems and the regional distribution of resource exploitation. The temporal dimension in Fig. 5 in turn means not only the acquisition of data for different periods of time, but also the study of developmental processes and changes of different kinds. The functioning of social systems, i.e. systems governing the utilization of resources, alters, or can be altered, with time in a way which natural systems, i.e. the universal laws of nature, cannot, even though development can be said to take place in nature as well, e.g. evolution and geological and climatological changes.

The methodological choices to be made in the study of regional development and the related resources question vary according to the problem being studied. Sant (1982: 36) stresses a problem-centred approach, noting that "if information about resources is to be more than a random set of facts, it has to be defined and collected purposefully. As Young (1973) has argued in relation to rural land evaluation, 'the approach must be problem-oriented, starting from a definition of aims and proceeding into whatever subject matter is necessary for their accomplishment.' Being purposeful means discriminating not only among different types and uses of resources, but also among the ways in which resources can be measured and valued."

Progress in the exploitation of natural resources and the facilities for doing so forms an important part of development in primary sector-dominated areas, and thus constitutes an object of resources management, which affects regional development. The stages in resource management with regard to the gathering together of the various elements involved are stated by Birch (1973: 4—10) to be the following: 1) a study of the systematic nature of resource management problems in terms of their spatial, ecological and institutional relationships, 2) the identification and evaluation of alternative adjustments in management and the cost-benefit characteristics of these, 3) the investigation of attitudes of both resource managers and resource users in relation to such alternative adjustments, and 4) the development of systems modelling in resource management (Gregory 1974: 378). Birch declares

the aim to be the construction of a general model for resource management, and Wilson (1973) tends to look in a similar direction, although he leaves the question of substance open. Wilson's resource management model describes the stages required in such research: 1) definition of the system of interest and characterization of its state, 2) scheduling of the nature of the management objectives for the system and the associated decision areas, 3) careful specification of the nature of possible models, 4) the application of these to specific real examples, and 5) the devising of possible empirical tests of validity.

This latter model for the research process will serve well for the study and evaluation of questions of resources, once the detailed declaration of objectives incorporated in stage (2), something which belongs specifically to planning, is replaced by a scientific definition of the problems to be examined and placed in initial position in the model. This provides an approach which is very general in character and does not specifically exclude any dimension of resource research mentioned above, although neither does it define the content or weighting of the dimensions. It will serve to steer the research and planning in a problem-oriented direction, however, while continuing to require both empirical application and the testing of validity and being capable of serving as both an explanatory model and a normative one.

The way in which the system to be studied is delimited depends on the problem for investigation. In the present case the viewpoint is connected with the development of a regional economy and the physical environment in which the relevant production system operates, resource use being taken as one aspect of core-periphery relations. The physical environment is the source of the resources employed by this economy and the target for the waste created, and it is this physical environment that serves as a kind of boundary condition for regional development, offering a finite amount of natural products and accepting the environmental loading resulting from human activity. Human activity and natural processes together make up an input-output network which offers a certain scope for economic activity and places certain constraints on it (O'Riordan 1971; Rasmussen & Reenberg 1980). It is this scope that is exploited by man. These interrelations between nature and the economy can be expressed in terms of a materials flow pattern based on a material balance model developed out of the input-output model and enabling the flows

of materials and energy in the production process to be monitored. This may then be incorporated as one element in a model of production and spatial relations. Although regional development is dependent on external factors, global economic growth and developmental uncertainty, for example, it is also to some extent selectable, e.g. via the implementation of regional policy. It is shaped in accordance with progressive changes in the system of production and in the spatial system occurring as time goes on. This present examination advances from a static to a dynamic viewpoint and from a descriptive mode of presentation to one which generates alternatives by means of normative assumptions. This enables the scope for the utilization of resources (including physical limitations, returns and capital layout) to be evaluated in the case of regional development in Northern Karelia.

Core-periphery relations in a regional system

Concepts

The core-periphery approach is a construct which has been discussed in many contexts, e.g. urbanization, staple products, growth centres, etc., in an attempt to interpret growth and development in a spatial system. It implies a view of economic development as a dependency relationship between a peripheral area and its core (Friedmann 1973; Wärneryd 1975), the latter serving as a centre of innovative change (Friedmann 1973). Such centres are understood in the context of the present research as foci for the administration and control of production and the generation of innovations. The rank order of core regions may be defined at four levels, the highest being the metropolis at the national level, followed by regional capitals, subregional centres and local service centres (Friedmann 1966: 218). These core areas thus form a spatial system of a hierarchical kind, a network which transmits impulses essential for production from one centre to another and out into the periphery. A core-periphery network is therefore one manifestation of the spatial division of labour.

Peripheral areas usually have a lower standard of living than the core areas, less broadly developed economic structures and a higher proportion of declining industries (Stöhr 1981: 73–74). They are essentially dependent on decisions regarding the steering of the economy, technology, capital investment, culture and political af-

fairs made in the centres. Economic development is in fact habitually looked on as a development which is exported to the periphery and entails a breakdown of these areas' own traditional modes of production, industrialization and pressure to adopt urban values (Friedmann 1973). Development in a core-periphery context takes place in different ways, i.e. gains different manifestations, depending on the properties of the area concerned and the details of the implementation of core-periphery relations. Thus it is possible to identify peripheries and cores of different types and different types of developmental trend operating within them.

One may also find outside the core areas certain upward-transitional areas of intensive growth and intensive utilization of resources (Friedmann 1966: 41–43). These are characterized by industrialization and a modern form of agriculture, and are usually located close to the core areas. Core areas are also frequently joined physically by development corridors, which constitute a special type of upward-transitional area. Resource frontier areas often border onto upward-transitional areas, for example, and comprise areas of expanding agriculture (continuous frontiers) or isolated sites of mining, etc. (non-continuous frontiers). Downward-transitional areas are old rural areas, locations of established settlement which have passed into a phase of stagnation or regression. Here one usually encounters problems in adaptation to structural changes in the economy, as reflected in unemployment and out-migration, for example. Such areas are usually located beyond the zone of core areas and upward-transitional areas. A fifth type consists of special problem regions, which require individual treatment because of their special nature, e.g. regions close to national borders, regions affected by drought, or regions suitable for the development of tourism. This core-periphery system of Friedmann is directly linked to Thünen's zones (Haggett 1979: 514). Admittedly the concept of space functions at a relatively abstract level in the case of core and periphery areas, and this should be borne in mind when operationalizing the regional system (cf. Brookfield 1975: 120). Effects of various kinds (alterations in demand, technological advances, changes in price levels, etc.) are brought to bear on the implementation of regional development via production processes, the whole production system being composed of many processes of different types, which react to these effects in different ways, causing the regional types to be

realized on the land surface in the form of combinations varying in degree. Their typology is built up of the developmental features which predominate in each given area at the stage of regional development reached at the moment in question.

The structure of the core-periphery network alters as changes occur in the structure of the economy, being shaped by the exploitation of natural resources, industrialization, improvements in communication networks and demographic changes (Palomäki 1972). In this sense the starting point for development in a peripheral area may be said to be the incorporation of a remote, usually sparsely populated area of little significance in commercial terms into the sphere of intensive economic exploitation, e.g. through mining or a branch of agriculture requiring additional land. The periphery then serves as a source of raw materials, and its network of town usually provide for the transport of these. Thus industrialization and the formation of core areas in the periphery normally begins from the towns responsible for the transport of such raw materials. The advent of manufacturing industry and increasing exchange of goods then increase the demand for labour in these towns, attracting population from the surrounding countryside. This leads to the formation of new towns at the central points for transport purposes, through the influence of economic growth and improved infrastructures. Development takes on different forms in different parts of the area, i.e. it undergoes areal differentiation. Once pronounced growth has been achieved in the major towns, overcrowding causes the focus of development to shift to progressively smaller centres. In the course of time these development patterns in the periphery also come to affect the chances for local and regional development, which add new distinctive features of their own to the general trend.

This philosophical construct based on core-periphery theory bears certain relations to the staple theory, and via this to the export-base and other multiplier effect theories. The fundamental notion behind the staple theory is that the periphery is attracted to participate in economic activity by virtue of its natural resource base, which dominates the conditions for production in the area and thereby the structure of its economy. The structure of a peripheral economy is thus essentially dependent on the exploitation of one or more natural resources, each of which yields a staple commodity, a mass product usual-

ly used as a semi-manufactured intermediate product in the area to which it is exported. Primary production and manufacturing based on natural resources, to the extent to which this is applicable, form the major foundation for productive activity in such an area, the remainder of the structure of production within the regional economy being geared to this. The products of the various sectors engaged in exploiting natural resources are exported to areas outside the periphery for further manufacture and/or consumption, and changes in demand, like changes in control factors such as capital, technology, etc., are dictated from the outside. Core-periphery relations create a situation in which external factors regulate the generation of staple products to a considerable extent and in this way exercise a decisive influence on development in the periphery (Peltonen 1982a: 20—25). The outcome is a set of core-periphery networks at different levels in the regional hierarchy as the manifestations and timing of development vary.

These areas acting as sources of staple products are in the majority of cases either resource frontier or downward-transitional areas, the former when demand for the staple product in question is on the increase or price levels alter so as to allow new resources to be exploited or the exploitation of existing ones to be intensified, and the latter if a decline in demand causes production to be reduced. A decline in demand will frequently also lead to a drop in prices, forcing the least profitable production units out of business. This effect is naturally concentrated on marginal production (less successful timber companies, small farms, etc.), which usually accounts for a high proportion of the economy in a peripheral region. In addition, a recession can turn the periphery into a downward-transitional region throughout, for if an industry has grown up in the periphery based on the manufacture of a staple product, any depression in this industry will be reflected in the regional economy through the chain of raw material supplies.

A model for peripheral relations

A simplified model can now be formulated to describe the exploitation of natural resources, structure of the labour force and interaction between different sectors of the economy in a system of three regions (Fig. 6). This model also contains a foreign sector, with which the national core-periphery system conducts its external trade. This model also serves to depict the spatial divi-

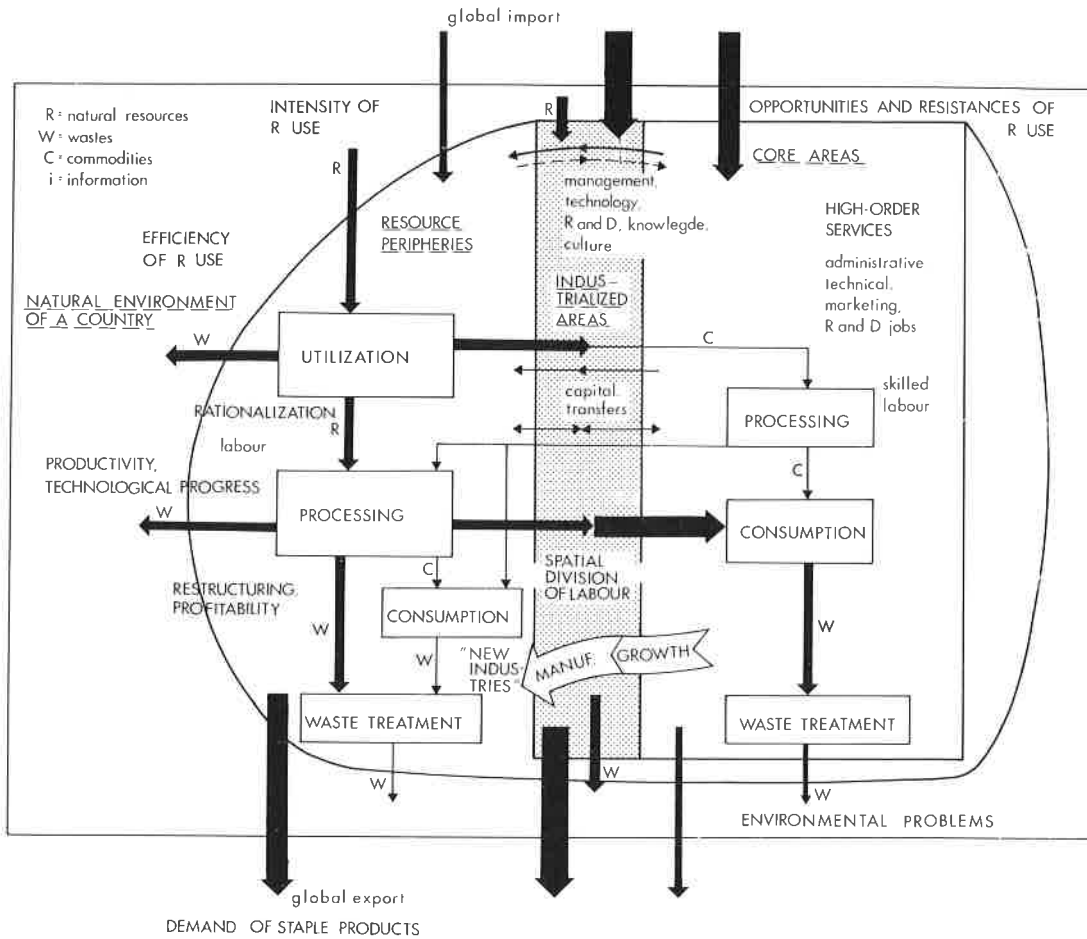

Fig. 6. Core-periphery interaction relations, development processes operative in peripheries and the manifestations of these. The thicker the arrow is the more significant is the interaction at that point.

sion of labour between the periphery and core area, and functions as a conceptual framework with relations capable of empirical verification which can be used to evaluate development in a peripheral economy. The model applies to that stage in core-periphery relations at which no significant increase is possible any longer in the extensive primary exploitation of natural resources. The dominant development feature then becomes rationalization of primary production and the industry associated with it. The model thus describes the promotion of other industries in the periphery.

Figure 6 involves areas with three types of economy. The core areas, as defined above, are responsible for producing goods and services based on the use of relatively highly skilled

labour. They are also the sites of the head offices of businesses, which in turn reach out in their functions into the periphery, which does not possess these functions which are essential to production (Watts 1981). The specialization in services found in core areas (high-order services: Britton 1978) also implies control over functions taking place in the periphery. This agglomeration tendency among high-order services such as finance, commercial services and administration is due to their need for mutual contacts, whereupon accumulation at a suitable hierarchical level becomes necessary for efficient working (Törnqvist 1978; Goddard 1978). The system of core areas in principle forms a hierarchical network, although a simplification is made here in that we shall examine predominantly the status of the na-

tional metropolis level in relation to the periphery at the regional level.

Located close to the core areas one finds the industrialized, and usually expanding upward-transitional areas which can frequently contain functions dependent on overseas inputs, but which are also linked with the more distant peripheries and core areas. In terms of the production of goods, and when viewed from the national perspective, these would form part of the periphery, for in the majority of instances they lack higher-level centres of innovation and administration. The industrial area indicated in Fig. 6 is scaled down to conform to Finnish conditions, where it represents an industrialized area outside the core region at the national metropolis level but with a predominantly growing population base and relatively high standards of affluence ('Industrialized Finland': Fig. 10). No detailed description of the structure of production and consumption in this area is presented (Fig. 6).

A *resource periphery* is defined as an area in which primary production and manufacturing based directly on this is of greater importance for the regional economy than elsewhere and in which chiefly staple products are involved. The natural resources of such an area, which is specialized in their exploitation, are usually transferred outside the area either directly or after only very low-level processing for further processing and consumption elsewhere. The resource peripheries thus generate products for export, a high proportion of which end up in the international core-periphery network.

The material, energy and information flows are depicted by arrows in Fig. 6. The level of generalization of the diagram nevertheless means that many details such as recycling of waste have been left out. The principal structural feature is the exploitation of natural resources from the resource peripheries (referred to below simply as peripheries). These are extracted from the resource base of the peripheries and used to manufacture intermediate and final products, usually of low degrees of processing, to meet global and national demands. The markets are most often global, in fact, e.g. for the products of the timber and mining industries, but may sometimes be principally national, e.g. foodstuffs in Finland. These connections between the periphery and the outside world form the network through which growth effects and shrinkage effects are realized. The processing of natural resources in particular tends to form production

chains which transmit such effects. The utilization and processing of natural resources also places some loading upon the environment, which in turn is concentrated in the peripheral area itself, while the labour input is mainly at the operative level, for the maintenance of production processes.

The material flows in the diagram are regarded as making up part of the core-periphery relations. Flows of materials are traditionally used to describe the external contacts of an area, i.e. to what extent it utilizes natural resources and generates waste (e.g. Douglas 1981; Newcombe 1977), and in the present case this approach is extended to cover material production as one part of the core-periphery division of labour.

Manufacturing growth is gradually moving away from the core areas, and to some extent also away from the industrialized areas towards the primary sector-dominated periphery (Fig. 6). In many developed countries this stage has already come to an end. Industrialization in non-metropolitan areas (counties with no continuous built-up areas of population over 50,000) was very pronounced in the USA in the 1960's, for instance (Haggett 1979: 353), and these areas increased their share of industrial production from 23.5% to 28.8% between the years 1962 and 1978. As far as industry itself was concerned, this growth would appear to have reached its peak in 1973, after which non-manufacturing employment began to increase in these areas (Haren & Holling 1979). In Finland the corresponding phase of industrialization in country areas, i.e. chiefly the rural communes, continued into the 1970's and early 1980's.

Efforts have been made to increase the advantages enjoyed by the peripheral areas by means of regional policy measures, and general improvements in infrastructure and communications have also added to these advantages and detracted from the relative importance of the agglomerations. At the same time the rise in costs in the core areas, in terms of land prices and labour, may also reduce the advantages of such locations for industries. The peripheries also lack the significant problems of overcrowding which urbanization has brought with it. All these features argue for more competitive cost levels in the peripheries compared with the core areas and lead us to expect an increase in suitable industrial activity in the former. Changes are also occurring all the time in production processes, and these may affect the extent to which profitable use can be made of the locational advantages

offered by the peripheries. Such changes may involve the quality of the labour available, possible production techniques, or the infrastructure demands of given industries. Regional development may thus be viewed as an outcome of changes in production, i.e. in processes and organization, and of the extent to which a developing infrastructure can attract industry to an area.

The spatial division of labour may be depicted in terms of intra-firm and intra-sectoral differences in the structure of production, and thereby in the distribution of resource utilization and environmental loading as well as inter-sectoral differences. The different demands placed upon the regional system by production processes and the qualitative differences existing in that system itself generate areal structures of different types depending on the branch of production concerned (Massey 1984: 67—82). Administration and production functions in a firm show areal differentiation, as manifested in qualification and wage differentials within the labour force (Fig. 6). These administrative functions of businesses may also be taken to include marketing, research and development, financing and other head office functions. Scientific and engineering skills and external advantages are of essential importance in product development, and many functions requiring intensive intercommunication can profit from a core area location, for it is only this that can offer the necessary functional environment. The present trend for multiple siting of companies and the growth of quaternary production tend to favour the formation of core area functions, and suggests that production will be generated in the core areas and their surroundings as long as the functional environment continues to meet the demands placed upon it by the production process (skills of the labour force, information connections, etc.).

The location of natural resources was an important criterion when choosing sites for industry at the early stages in the development of resource peripheries as far as those production processes which made use of such resources were concerned, but the improvement of transport routes has reduced this dependence on the location of raw material supplies. Production units have increased in size, head office functions have become divorced from manufacturing functions, and further processing has tended to be located closer to the eventual markets. Rationalization has taken place in primary production, and 'new industries' have been located in the periphery, altering the significance of its traditional

branches of production and adding new features as the peripheral economy grows.

When production is of a routine nature, a simple assembly line, it is the cost and availability of labour and capital that chiefly determines the location of the factory, and these factors may well argue in favour of the periphery, partly due to the regional policy subsidies available, and the result will be the creation of new jobs in that area. This will lead to industrialization in those peripheral areas where there is a general excess of labour and capital expenditure is lower (cheaper loans, lower land prices, etc.). Where a firm has several branches, management and know-how tend to be located in the core areas, but expansion may well take place in functions and parts of the production process in which it is not necessary to take advantage of the facilities offered by an agglomeration. One consequence of this spatial division of labour is the high proportion of the industrial labour force engaged in routine work in the peripheries. Industrialization in sectors beyond the scope of traditional staple production need not necessarily mean any reduction in the control exercised by the core area, however, for this will simply take on new forms connected with the sale and acquisition of intermediate products and with intra-sectoral and intra-firm divisions of labour. The recession in traditional industrial functions in the core areas may well mean that they gain new forms of production which are more profitable, which will mean in turn that the regional division of labour and the differences between regions will be preserved, only their manifestations being subject to change. Any significant deconcentration of core area functions or industrial modes of production would seem improbable in the near future in major cities of the kind found in Finland or in any country without the detrimental aspects of the city way of life.

A substantial proportion of the incomes in peripheral areas come from trade within the area. No attempt is made in Fig. 6 to describe the structure of the money flow generated in this way. On the other hand, many investment decisions relevant to the periphery are taken in the core areas, and the returns on these investments are realized in accordance with financial markets in those areas, the profits chiefly being located in the core areas as well (Fig. 6: capital-transfers). This control system applies particularly in industry, as agriculture and to a great extent forestry and private services remain in local ownership. If one sets out to examine the background to the money

flow in breadth, the question of core-periphery differences in the structure of production, compensation for various factors involved in production, product prices and transfers of income from one region to another proves a highly complex and somewhat speculative one, albeit interesting from a theoretical viewpoint (Andersson 1976). These transfers, etc. are indicated in Figure 6 as being bidirectional. Together with production intended for the local market and the incomes resulting from this, the core-periphery relation implied in the above exports, with their production factor compensations and transfers of income, will be realized in the last resort in terms of standard of living and its areal differences.

Core-periphery relations are in a state of continual change, the areas concerned altering as economic development proceeds. Theories of regional development can lead to quite different concepts of change in peripheral areas, concepts which can be divided into three groups. Firstly, a peripheral status can be achieved by other areas suffering from temporary regional development problems caused by changes in the structure of production, i.e. problems of adaptation. Secondly, peripheries can perpetually lag behind the industrialized areas, in which case they will also drag behind developmentally, and thirdly, differences in development may be divergent in kind, in which case the regional trend is one of cumulative recession. Theoretical justifications and empirical evidence can be found for all these viewpoints, but the eventual outcome is also dependent to a great extent on the angle from which the regional development concerned is examined (employment, growth, composition of incomes, etc.).

What are the factors influence regional development, and what is the eventual outcome of such development at each stage in history? Regional development does not follow an automatic course, in the manner of a natural law, but rather it is a result of human endeavour, governed by decisions regarding demand, investments, etc. and controlled by institutionally regulated economic invariances.

The starting point for examining the dynamics of a peripheral economy in Chapter "Revising..." is taken to comprise market trends and opportunities for the taking of independent decisions, where market trends are reflected in demand and profitability factors, etc. and decision-making opportunities in various types of opening for investment. These opportunities (natural resources, labour, transport, etc.) both create and

restrict the chances for development. Changes at the level of the individual institution aggregate to form development processes, and these processes are manifested in various ways in the spatial system. Since quite different types of developmental process may be observed at different areal levels, generalizations tend to indicate the dominant developmental features. The theory of regional development is clearly the outcome of a combination of factors, weighted in different ways depending on technological advances and progress made in marketing, and also on the spatial system under examination.

This hypothetical model, Fig. 6 and its interpretation, is applied to Finnish conditions here in the sense that Northern Karelia forms a resource periphery and Helsinki with its surrounding towns a core area. Helsinki, of course, as a relatively small capital city by international standards, is a highly important core area only within the areal system of Finland, while the province of Northern Karelia constitutes a periphery at the regional level with its own internal core-periphery relations.

Core-periphery structure and natural resources

Structure of production and control functions

Joensuu is the largest town in Northern Karelia in terms of population and at the same time serves as a regional capital. It has a higher proportion of its working population engaged in service functions than any other town in the region (Fig. 7), and is the regional centre for provincial-level administration, the regional offices of businesses and educational, financial and medical services.

The 20 largest employers in Northern Karelia account for approx. a half of the total labour force engaged in industry (Pohjois-Karjalan . . . 1985: 33), although of these only two processors of foodstuffs and two printing works actually have their head offices in Northern Karelia. Of the remainder, 11 had their headquarters in the Helsinki district in 1985 (i.e. in Helsinki, Espoo, Vantaa or Kauniainen), one at Nurmijärvi, also in the province of Uusimaa, two in Häme, at Nokia and Lahti, and one each in the provinces of Mikkeli and Central Finland, at Heinola and

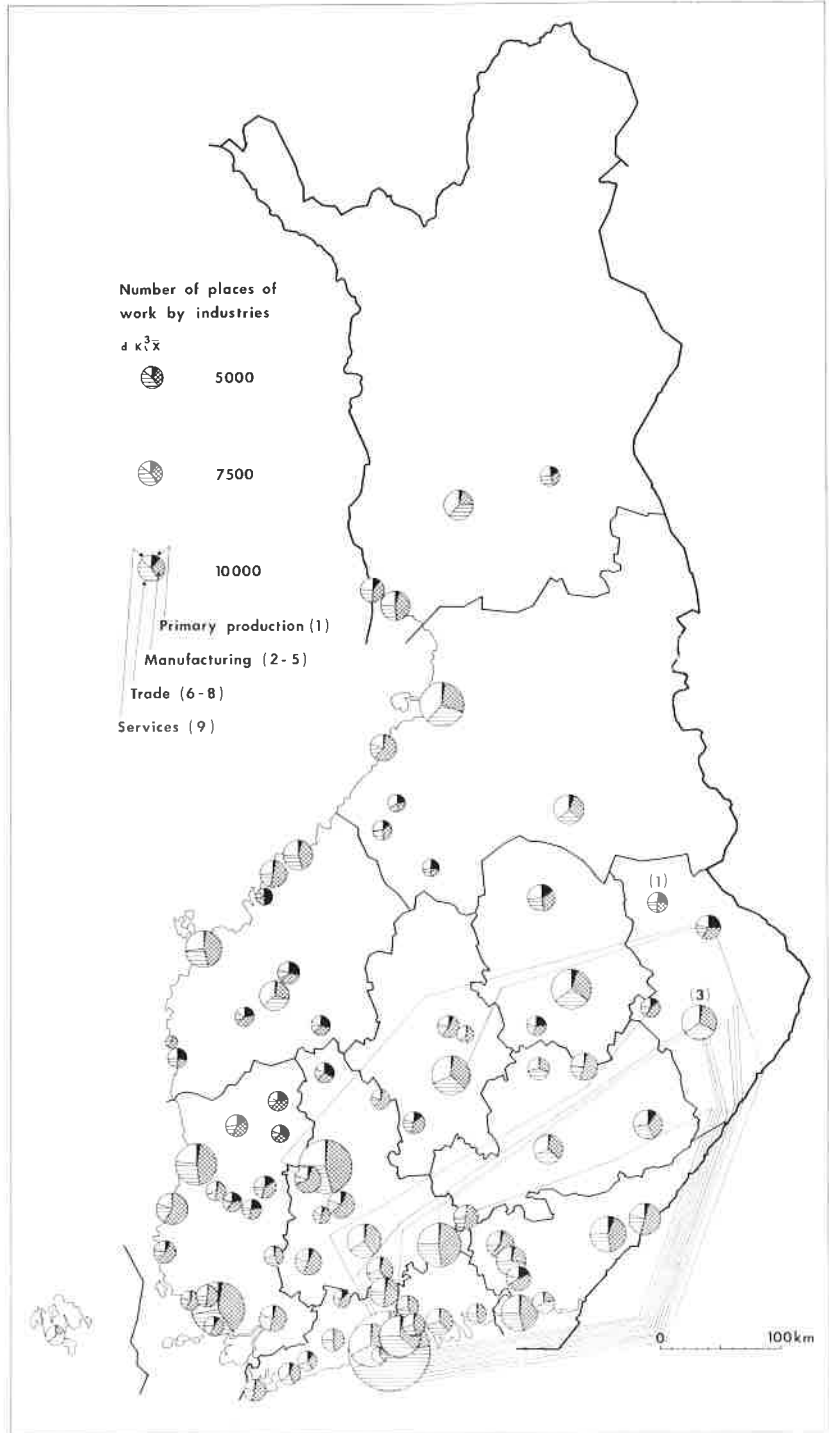

Fig. 7. The system of urban centres in Finland, a numbers of jobs by sectors of the economy in 1980 (SVT VI C: 106 I C). Also locations of the head offices of the 20 largest employers in Northern Karelia. Numbers of such head offices in Northern Karelia indicated in parentheses.

Jyväskylä respectively (Fig. 7). It is particularly significant that no mining companies or notable wood processing companies acting as employers in Northern Karelia have their head offices there. This means in turn that high-level services of the kind associated with head office functions and the information channels which these bring with them are substantially underdeveloped and the flow of information is very much of a practical implementation kind. There are few functions in the region that require large quantities of new information or indulge in production processes that demand a complex data input (for the functions of an enterprise, see Wood 1969).

Northern Karelia accounted for 3.2% of the total labour force in Finland in 1978 (Regional accounting 1976/1978), its highest proportions of persons employed in specific fields being recorded in primary production and first degree manufacturing (Table 1). In the wood processing industries, with the exception of sawn timber, and the food manufacturing section the region possessed less than 3.2% of the number employed in Finland as a whole. Thus manufacturing based on natural resources forms very short processing chains, there being no paper-making in the region at all, for instance.

If by new industry we refer to rapidly expanding branches of industry which are atypical of the industrial structure of the resource peripheries into which they are introduced, one would define clothing, chemicals, metal products, machinery and some other branches of manufacturing as falling into this category as far as the region is concerned (see section "Resources and waste..."). In all cases of such new fields the proportion of the labour force employed nationally in these which is located in Northern Karelia remains below 2%, e.g. only 0.3% of those employed in the manufacture of electronics products in Finland in 1978 were working in this region (SIC 383, 385) and only 1.8% of those engaged in other manufacturing (SIC 39).

The province's share of total employment in the public sector was a little higher than the mean level of 3.2%, reaching 3.7% (Table 1), partly because the administration is responsible for certain functions which extend over areas greater than the province itself, due to associations of communes crossing the provincial boundary, and partly because of its importance as an educational centre by virtue of the University of Joensuu.

The province of Uusimaa, and most notably the Helsinki conurbation, may be said to represent a well-developed, affluent part of the

Table 1. Percentages of the total labour force in certain branches over the whole country employed in the provinces of Uusimaa and Northern Karelia in 1978 (Regional accounting 1976/1978). For SIC codes, see Standard Industrial... (1972).

	%	SIC codes
Uusimaa:		
— commercial services	70	(831-3)
— head offices	60	(0)
— wholesale trading	59	(61)
— printing and publishing	52	(342)
— political and other organizations	50	(935-94)
— manufacture of electrical goods	49	(383, 385)
— finance and insurance	47	(81, 82)
— other manufacturing	40	(39)
— social security funds	45	
— government administration	33	
— local authorities	23	
Northern Karelia:		
— mining	17.6	(2)
— forestry	8.3	(12)
— agriculture	5.7	(111, 112)
— timber industry	4.6	(331)
— education and research	3.9	(931, 932)
— medical services	3.5	(933)
— social services	3.2	(934)
— public authorities	3.7	
— local authorities	3.8	

country. There are marked differences in development even within Uusimaa, of course, but nowhere does the level of unemployment reach as high as 10%, the average for Northern Karelia (Uudenmaan kuntien kehityserot 1984). The province contained 26% of the employed working population of Finland in 1978 (Regional accounting 1976/78), and accounted for 36% of the total value added in the service sector in 1980 (Fig. 8). The high proportion in this sector is a consequence of the location many private service functions and the upper levels of the public administration in Uusimaa. Measured in terms of labour input, the province accounts for over half of the country's production in commercial functions, head office and management functions and wholesale trade (Table 1), these functions being heavily concentrated in the Helsinki conurbation.

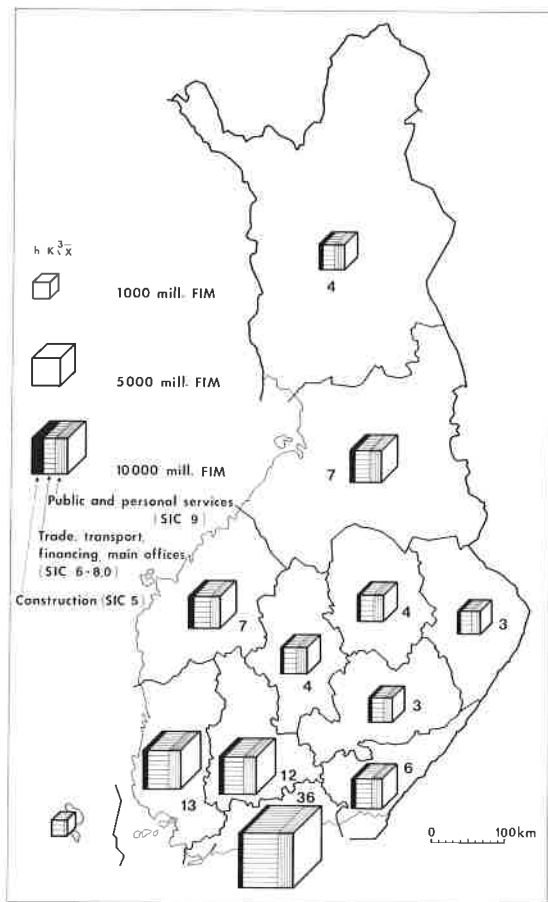

Fig. 8. Value added in the service sector in 1980, by branches of activity and provinces. The figures indicate the percentages of the total value added for Finland accounted for by each province (Regional accounting 1980).

The proportion of employment in the public sector in Uusimaa in 1980 was slightly higher than the mean for the country as a whole and grown in this sector during the 1970's slower than the national average (Kekki 1984: 30—40), but the importance of the region, and especially the Helsinki district, in this sphere is accentuated by the fact that it contains the highest levels of administrative and economic services. Thus employment in the civil service is overrepresented in relation to the local authorities, whose proportion of the labour force is lower than the mean for the whole country.

The Helsinki conurbation fell behind a little in relative terms as a provider of services during

the 1970's, with the exception of some services aimed at the business sector, i.e. finance, insurance, property and commercial services (YTV 1983: 28). The Helsinki conurbation is especially the start-up place of the newest and most advanced business services (Järvinen 1987). The province of Uusimaa accounted for 49% of all expenditure on research and development by private companies in 1979, 77% of that by the public sector and 40% of that by the universities (YTV 1983: 49). Helsinki has developed greatly as a site for the head offices of companies since the Second World War (Peltonen 1982b: 191), but there are also signs of damping development in the 1970's (YTV 1983; Regional accounting 1976/1978, 1980).

On the other hand, Helsinki has been losing its status as a location for industry steadily over the last twenty years or so. It is characteristic of the capital and of Uusimaa in general that the proportion of manufacturing involving a high degree of working up is greater than in the country as a whole (1954—70; Helsingin kaupunki 1978: 10). It is manufacturing of this kind, of course, that requires the most advanced technical skills, needs the best communications networks for the transmission of information and involves the most complex assembly tasks. Examples of this include the location of printing and publishing works and the manufacturing of electrical goods in Uusimaa (Table 1), fields which are closely connected with information generation and service functions.

Within the professions concerned directly with information, 37% of the country's work force are employed in Uusimaa (Mella & Vuorinen 1984: 9—11). These fields may be taken to include academic and technological work, marketing, the compilation of information, consultancy, other generation of information, administration, process control, office work, education, communications, the use of communication media and equipment and postal and telegraph services (definition employed by the OECD, Mella & Vuorinen 1984: 9). The need for personal contacts and discussions in connection with the making of decisions is usually great where high-level services and head office functions are concerned, which in turn leads to the concentration of such functions in large centres of diverse character (see Törnqvist 1978). The differences in the nature of the tasks performed are also reflected in variations in staff-worker relationships between peripheral and core areas and in salary differentials (Table 2).

Table 2. Structure and wage levels of the labour force in 1978 in Northern Karelia and Uusimaa (SVT XVIII A: 99).

		Staff per 100 workers	Mean wage FIM/yr	
			staff	workers
Uusimaa	towns	57	50 135	34 281
	countryside	36	47 253	32 985
Northern Karelia	towns	25	42 076	32 157
	countryside	19	44 396	31 514

The pattern of income flows of various types between a periphery and a core area is depicted in Fig. 6, where this includes profits accruing to a core area on investments made in the periphery, subsidies payable under regional development policies, etc. The core areas are naturally responsible for the majority of the financial decisions and capital incomes, while net incomes are granted to the peripheral areas usually through the agency of the public authorities. Thus 50% of the incomes of private persons from property holdings in 1981 accrued to the province of Uusimaa, as did 54% of the taxable incomes of companies (SVT IV B: 47: 54, 100). Similarly 38% of all deposits in banks in that year were made with branches in Uusimaa and 94% of all investment assets purchased by banks was located in the province (SVT VII C: 72: 39). In contrast, net transfers of income by the public authorities were directed towards the development regions, chiefly Northern Finland, the net figure being most pronouncedly negative precisely in the case of Uusimaa (see Kultalahti & Kultalahti 1978; Inkilä—Rauhala 1979). Such money flow calculations are nevertheless extremely problematical on account of the many spin-off effects that such transfers of income can imply, as well as questions of head office functions, market areas and other factors.

Relatively few decisions connected with the planning and organization of production are taken in the development regions themselves, since the major companies active there have their main offices in the Helsinki area, and there are exceptionally few cases in which a company has its headquarters in a development region and operates exclusively in that region or has only a subsidiary branch in the industrialized part of the country. Companies with branches in different

localities account for 2/3 of all employment in industry in Finland (Virkkala 1983: 3—11).

The core area in Finland at the national metropolis level thus serves as the principal location for services at the highest level and the associated industry, and other industry which favours population agglomerations. Such services and associated industry may be referred to as core area industries of core functions. Information of essential importance for production development or decision-making is brought to the periphery from the core area, just as the core is also clearly dominant in terms of assignment of capital. A high degree of working up and R & D and administrative functions in the manufacturing industries of the core area naturally also implies a highly qualified labour force, as may be assumed from the structure of production (c.f. section "Core-periphery relations..." and Fig. 6). Thus the core area forms a complex agglomeration specialized in the taking of economic and administrative decisions, with a diversity of communication channels which provide favourable conditions for the start-up new, most advanced, high-order services. There is no doubt at all that a concentration of functions of varying types will also be in a position to create the right conditions for the development of these functions in the future. One factor that may restrict this development, however, is a rise in cost levels brought about by overcrowding. Nevertheless, any change in the spatial structure of the control functions in the core-periphery model (sector "Core-periphery relations...") would necessitate quite far-reaching alterations on the processes and structures directing the organization of functions (e.g. administrative devolution), and consequently alterations in core areas are usually the product of processes taking place over a matter of several decades (see Peltonen 1982b).

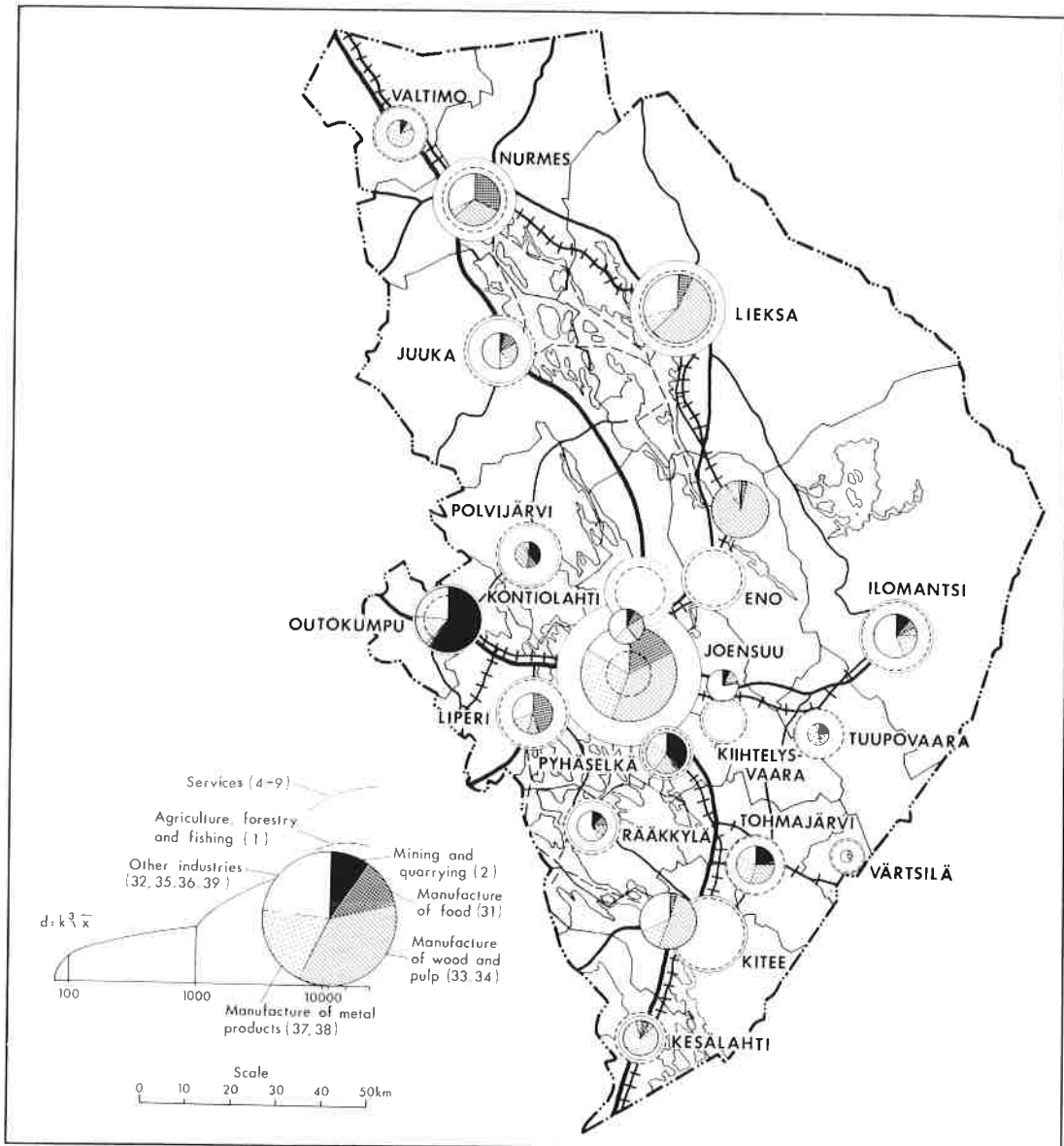

Fig. 9. Locations of jobs in Northern Karelia in 1980, by communes. The circle representing industrial jobs is centred on that agglomeration in the commune which offers the majority of the jobs (SVT VI C: 106 I C: Pohjois-Karjalan seutukaavaliitto 1982b).

Changes in industry and employment in Northern Karelia

Background

The structure of production in Northern Karelia has been based in the past and continues to be based to a very great extent on agriculture and

forestry and manufacturing which makes use of the products of these. The principal agricultural areas are in the southern and south-western parts of the province, where the area of arable land per farm is higher than the average for the whole province and arable land makes up a large proportion of the area of each commune (SVT III: 53; STV 1970). North of a line Tohmajär-

vi—Pyhäselkä—Polvijärvi agriculture is dominated more by small farms and smaller proportions of the land area of the communes consist of arable land (Fig. 9), although Nurmes and Valtimo are again communes with a higher than average arable area per farm. There were seven communes in 1980 in which agriculture and forestry employed more people than did industry and the service sector (Fig. 9): Juuka, Polvijärvi, Rääkkylä, Valtimo, Tuupovaara, Kesälahti and Kiihtelysvaara. These are all communes of the interior of the province which are fairly remote and have poor external road and rail communications, and thus the dominant role of agriculture and forestry in their employment structure may be interpreted more as a symptom of general underdevelopment than as an indication of particularly successful farming, since the really significant agricultural communes such as Kitee and Liperi have a majority of their working population in the service sector.

Food processing is located chiefly in Joensuu, Nurmes, Liperi and Lieksa, where the largest factories operate on a cooperative basis, while wood processing is concentrated beside the main waterways and railway lines, in Joensuu, Lieksa, Eno, Kitee and Nurmes. Outokumpu has been a significant mining community since the inception of mining there in 1913. The large wood processing concerns at Eno and Lieksa, and also the mine at Outokumpu, are in the hands of government-owned companies (Fig. 9).

The chief industrial towns in Northern Karelia have a long history of industry, having in most cases possessed sawmills and dairies from the 19th century onwards. The region also has some iron, glass and brick works. There has been a sawmill at Joensuu since the end of the 18th century, and the present plywood factory dates back to 1918, when it took over from the previous bobbin factory. The communes of Kitee, Tohmajärvi and Värtsilä were also important industrial locations in the 18th and 19th centuries by the standards of the day, e.g. the sawmill and engineering works founded at Puhos in Kitee in 1744, but many of these factories have since closed down, e.g. the iron works at Nurmes and Ilomantsi. Joensuu emerged as the centre for Northern Karelia in the early 19th century, prior to which time the main market in the region had been at Tohmajärvi.

The population of Northern Karelia has growth rapidly during the present century, relying primarily on agriculture and forestry for a livelihood. The numbers of both inhabitants and

farms increased markedly following the Second World War, and by the 1960's a complex rural infrastructure had developed based on the needs of a predominantly agrarian society. Over 60% of the working population were still engaged in agriculture and forestry in 1960 (Table 3), while the little industry which existed was dominated by manufacturing based on local raw materials. Natural, human and cultural resources combined to form an economic system based on primary production and the processing of its products.

Transformation of the occupational structure

The period from 1960 to 1980 saw a rise of the service sector to dominate the occupational structure in Northern Karelia, with a significant decline in the role of the primary sector (Fig. 10). Particularly marked changes also took place in the employment situation, for where the combination of agricultural work in the summer and forestry work in the winter formed the principal routine for the rural population in the early 1960's, these two components then began to decline rapidly in currency, the former because of rationalization in farming and the latter because of the mechanization of forestry. 37 000 jobs were shed in the primary sector in 1960—80 (Table 3), while the labour force occupied in the service sector increased by 13 600 and that in industry by 6300. This trend naturally led to a crisis in the employment situation, especially as it

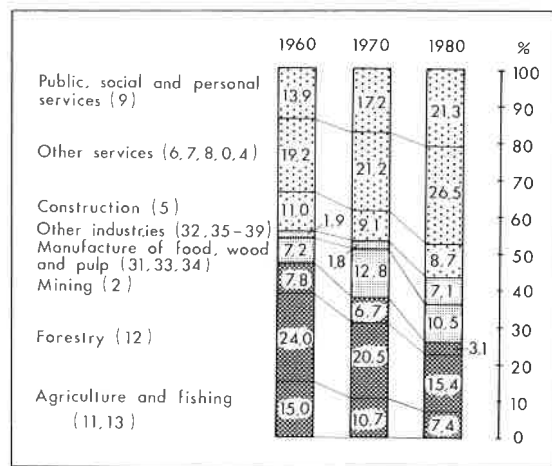

Fig. 10. Distribution of the gross regional product of Northern Karelia by sectors of the economy (Regional accounting 1960/1970, 1980).

Table 3. Employees in Northern Karelia by industry (percentage of whole country in parentheses).

Sector:	1960	1970	1980/1979
Agriculture and forestry	54 199 (7.7)	30 633 (7.1)	18 099 (6.5)
Agriculture	42 053 (7.0)	24 329 (6.7)	13 721 (5.8)
Forestry (SIC 12-3)	12 146 (10.4)	6 304 (9.7)	4 377 (10.1)
Mining and quarrying	1 341 (20.6)	1 199 (17.1)	1 420 (14.0)
Power and water	464 (2.6)	675 (2.7)	689 (2.8)
Manufacturing	4 488 (1.3)	6 385 (1.4)	10 499 (2.1)
Food processing	997 (2.6)	1 420 (2.8)	1 520 (2.9)
Wood (excl. furniture)	1 767 (3.7)	2 415 (5.4)	2 509 (5.6)
Pulp and paper	723 (1.9)	1 035 (2.3)	1 275 (2.6)
Clothing (SIC 32)	158 (0.2)	202 (0.3)	1 309 (1.9)
Metals (SIC 37 and 38)	413 (0.4)	682 (0.5)	1 947 (1.1)
Minerals, chemicals, etc.	430 (0.6)	631 (0.6)	1 939 (1.7)
Services	28 230 (3.3)	35 769 (3.2)	41 814 (3.2)

Sources: Population census results for 1960, 1970 and 1980 (economically active population). Manufacturing employment data (SIC 3) are from the industrial statistics for 1960, 1970 and 1979, which give total figures for manufacturing which are about 2000 smaller than population census. The 1960 figures for manufacturing are classified according to SIC (Standard Industrial . . . 1972). SVT VI C: 103, 104, 106; SVT XVIII A: 76, 92, 100.

occurred at the time when the post-war bulge generation was just reaching working age.

Further problems were caused in the 1960's by a surplus in agricultural products, and a revision of the agricultural taxation system at the end of that decade further weakened the position of the smaller farms. All in all, farms of at least 1 ha arable land in Northern Karelia decreased in number from 22 400 to 20 224 between 1959 and 1969, and still more sharply over the next decade, to only 13 884 by 1981 (SVT III: 67; STV 1983), a trend that affected precisely the smallest of these farms, since units of at least 3 ha arable land continued to increase in number in the region in the 1960's (Honkanen et al. 1973). By 1969 the farms of Northern Karelia had a working population of 321 persons per 1000 arable hectares, compared with 133 persons in Uusimaa and an average of 224 for the country as a whole (STV 1972: 87). Further reductions in the agricultural labour force took place over the next ten years, however, largely as a consequence of rationalization, since for the most part production increased at the same time. In fact figures for most agricultural products, e.g. crop yields, milk production, etc., rose steadily between 1960 and 1980 (SVT III: 56; SVT III: 79).

One alternative to unemployment as the supply of excess labour steadily increased was migration, and this opportunity was certainly taken, as the population of the province declined by 8.2% in 1960-69 and 4.7% in 1970-79 (Lind-

gren & Ritamies 1981: 24). The effect of the bulge generation is evident in the age pyramid for 1960 (Fig. 11), but the large age class 0-14 years is seen to have virtually halved by 1980, a feature also attributable to migration. This means that no marked pressure of population reaching working age can be expected to affect the situation in the next 20-30 years, the only threat being pronounced in-migration, which would seem highly unlikely.

The reduction in primary sector labour requirements, together with migration, has meant a substantial decline in population for the rural communes of this region, a trend which has been reflected in the level of services, substantial declines having taken place in both public and private services (i.e. schools, shops, etc.) in the country districts. The only area with a constant total net in-migration over the period 1960-1980 was Joensuu itself, which may in this sense be regarded as a developing local core area, whereas Northern Karelia as a whole represents an area of the downward-transitional type.

The pronounced changes which have taken place in the occupational structure of Northern Karelia over recent decades form part of the general change in economic structure, i.e. a move towards industrialization and the rationalization of agriculture and forestry. Great interest was shown in the 1960's in increasing the GNP, intensifying the use made of economic resources and achieving a modernization of society at large.

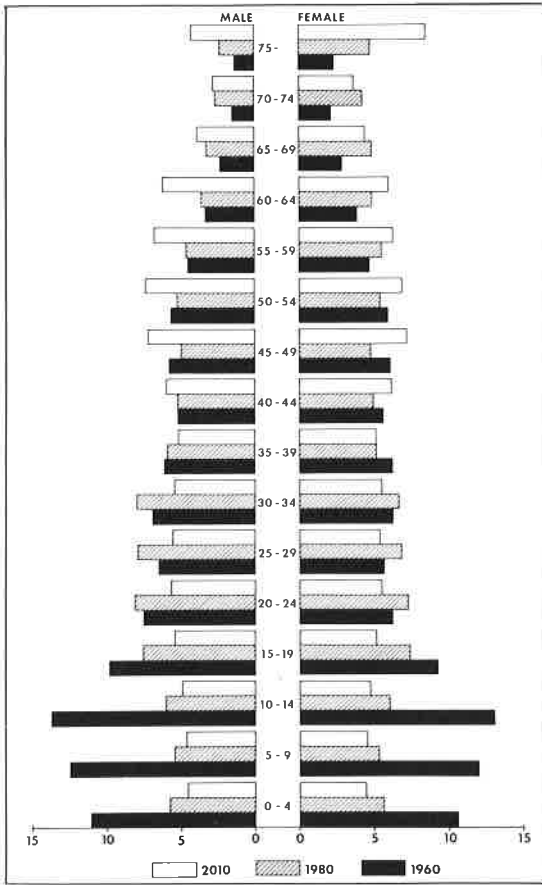

Fig. 11. Age structure of the population of Northern Karelia (SVT VI C: 103, C: 106 I A; Pohjois-Karjalainen seutukaavaliitto 1984b).

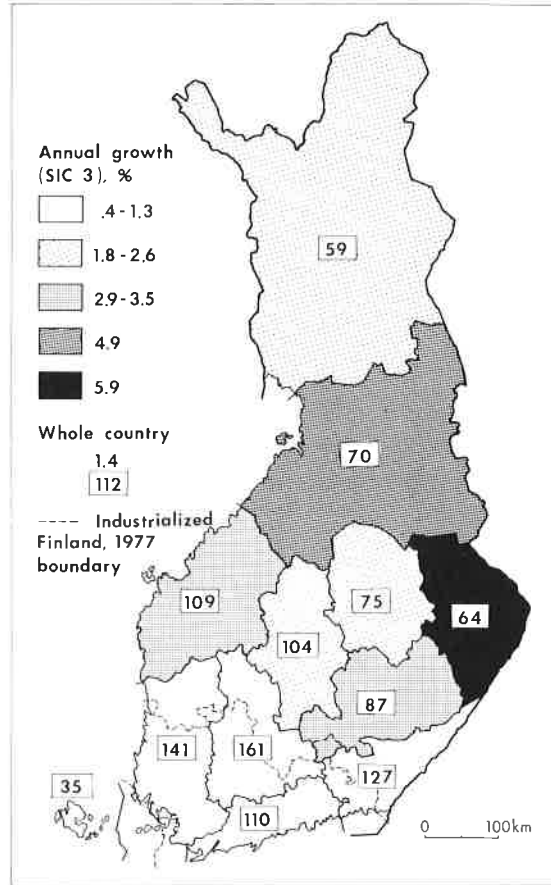

Fig. 12. Percentage change in numbers employed in manufacturing (SIC 3) over the period 1970—80 (shading) and numbers employed per 1000 inhabitants in 1980 (figures for provinces) (SVT XVIII A: 92, A: 101; STV 1981).

The key idea was the creation of a state of rapid economic growth over the whole country, the main means for doing so being perceived to be industrialization (Kiljunen 1979: 141—150).

Much was done in the 1960's to develop the infrastructure of the region by building roads, railways and waterways, and the first regional policy measures to promote industrialization were taken towards the end of that decade. These consisted largely of loans and grants intended to attract industrial companies to the area. An industrial estate was established at Lieksa in the early 1970's, and that decade became one of rapid proportional increases in industrial employment in the province as a whole (Fig. 12), so that where the increase over the period 1960—70 was 42% (SIC 3), it reached as high as 78% in 1970—80.

The majority of the growth in the industrial labour force affected branches of manufacturing which lay outside the traditional fields based on the processing of the products of local natural resources, a trend which was greatly aided by the development of the infrastructure and the implementation of regional measures (Tervo 1983: 143—147).

The growth in employment in manufacturing within the province of Northern Karelia in the period 1970—80 represented one of the most rapid regional growth rates anywhere in the Nordic countries (Regional utveckling . . . 1982: 73), as may be appreciated from the fact that the increase over Finland as a whole during that period was 15.2% and that in Uusimaa only 4.2%, the lowest of any province in the country (Fig.

12). In fact the growth in the labour force at this time was relatively small throughout Industrial Finland, an area supplying 65% of the country's manufactured products (for a delimitation of 'Industrial Finland', see Atlas of Finland 1983: 25). This trend which took place in the 1970's helped Northern Karelia to make up some ground with respect to other parts of the country, since the initial level at the beginning of the decade was very low compared with all the other provinces. This means, of course, that even by 1980 industrialization in the region was at a low level by national standards in spite of the sharp increase achieved in percentage terms (Fig. 12).

Employment in the manufacturing industries over the country as a whole expanded by about 150 000 persons in the interval 1960—80, a figure which is considerably less than the decrease in employment in agriculture and forestry, 435 000. The root of the problem of regional development indeed lay in the structural changes that were taking place in the economy and the post-war boom in the labour force (cf. Tervo 1983: 63). The goal of modernization naturally played a part in these changes, but the crux of the matter was that there simply was no demand for the increased labour that was available. There were even suggestions of a system of industrial location licences to add more weight to the regional policy measures, but these would in effect have been useful only for a short period early in the 1970's, for otherwise there were in any case not enough manufacturing jobs to go round.

The discrepancy between supply and demand on the labour market was so enormous in the case of Northern Karelia that an equilibrium could not be achieved by means of regional policy alone. Indeed the growth in industry in the region still only offered a limited number of new jobs in numerical terms, some 4000 generated outside the foodstuffs, wood, pulp and paper industry over a span of 20 years. On the other hand, the service sector could not be expected to absorb the rest of the free labour, even though in absolute terms the increase in its labour force was more than three times that achieved in the 'new industries' and more than twice that in the industrial sector as a whole (SIC 2—4).

In spite of the new industries introduced into the region, staple products and the exportation of a high proportion of the production achieved continued to be the dominant features of outward trade in the mid-1970's. 56% of the exports from Northern Karelia to markets elsewhere in Finland and abroad consisted of the products of the wood processing and timber industries, 15% foodstuffs

and 9% mining products, although this did mean a drop in the combined proportion of these traditional products from 90% to 80% relative to the situation in 1970. The proportion of mining products exported from the region had declined during this period, and the proportion of products of the wood processing factories had been reduced by the recession which affected the industry in the mid-1970's and the temporary cut-back in sawmill production. Thus the structure of the region's exports can be said to have been influenced not only by the arrival of new industries but also by changes which were taking place in the exploitation and processing of its own natural resources.

Viewed in the above light, it is clear that the economic transition of the period 1960—80 was brought about by a combination of new industry and qualitative and quantitative changes in the existing structure of production, following a principle that states that the structure of production will tend to move away from the exploitation of natural resources towards manufacturing based on these and the importation of raw materials (Hewett 1929). This direction of development is nevertheless present only in a limited form in Northern Karelia, being visible most clearly in the wood processing industry over the period 1960—80, e.g. in a shift towards pulp and chipboard production. The new industries introduced into the area in the 1970's on the other hand, represented branches of production which had been lacking entirely in the 1950's and 1960's, branches which had few local connections (channels for multiplier effects, outlets for the traditional skills of the local labour force, etc.) and for which the location criteria were frequently merely the availability of labour and the subsidies offered under regional development legislation.

Regional development plans drawn up in the late 1970's and early 1980's laid stress on the exploitation of local natural resources (Pohjois-Karjalan . . . 1978; Korhonen & Tykkyläinen 1983), and later on the establishment of small businesses (training for entrepreneurs, rural jobs subsidy schemes, etc.). The motives lying behind this undoubtedly arose out of the slowing down in economic expansion, the disadvantages of the existing spatial division of labour and an attempt to find fields in which location in Northern Karelia would prove a permanent advantage (e.g. due to reliance on natural resources). In this way the traditional regional subsidy strategy was complemented with ideas that showed connections with the strategy of territorial development (cf.

Friedmann & Weaver 1979; Stöhr & Taylor 1981).

The resource base: stocks, flows and utilization

Northern Karelia has a higher value added from primary production than any other province in Finland, 23.2% (Regional accounting 1976/1978). Climatic conditions are particularly favourable for milk production and forestry, and mining is also significant (Fig. 13).

The resource base for the region may be described in the manner of the following table, which contains information on all the principal natural resources and their exploitation. The data are from 1975 unless otherwise indicated, the figures in parentheses being percentages of the national totals:

These figures serve in some measure to show the extent of the natural resources available, at least when compared per inhabitant at the national level (given that Northern Karelia accounts for 3.7% of the country's population). Measured per unit area, the region's forest resources come very close to its share of the country's land area, while milk production takes on considerable significance.

Agriculture in the region is dominated by the smallness of the farms, the climate being unsatisfactory for grain crops, particularly wheat. Thus production is centred around fodder crops, milk and beef. Although the markets for the latter two have grown slowly, productivity in agriculture has increased appreciably, and cultivation has been discontinued on large areas of chiefly poorly productive arable land. Thus 9.6% of the arable land in the region in 1980 was lying fallow (STV 1982: 84), slightly more than the average for the

Renewable resources: flows and cycles

Solar energy inflow:	2800 TJ/yr sq km
Hydroelectric power (1981)	843 Gwh (6.2)
Water (total use):	62 mill. m ³

Renewable resources: biological

Agricultural output in 1000 tonnes (1979):

Grains:	110.7	(3.4)	of which wheat (0.6)
Potatoes	28.6	(4.2)	
Hay and silage	495.4	(8.1)	
Meat	8.5	(2.9)	
Milk	219.0	(7.0)	

Forestry: total volume of growing stock in mill. m³ (solid) incl. bark (Northern Karelian Forestry Board district 1971—76):

Pine:	50.4	(7.35)
Spruce:	41.0	(7.22)
Hardwoods:	23.2	(8.72)
Total:	114.7	(7.55)

Forest budget (1978), units as above:

Total cut:	3.73	(7.87)	to export 1975: 54 %
Allowable cut:	4.66	(7.90)	cf. Growth 4.40
Excess:	.93	(8.05)	

Non-renewable resources: restored

Resource	Reserves	Total use	Exports	
Gravel:	2700 (8.7)	1.85	—	mill. m ³
Copper ore:	10	1.03	1.03	mill. tonnes

Non-renewable resources: non-restored

Resource	Reserves	Total use	Exports	
Peat:	129 (<10)	.3	.0025	mill. m ³
Oil fuels (imports 1981):	285 (2.7)			1000 tonnes

Areal resources, sq.km.:

Water area:	3475	(11.0)	
Forest land:	15917	(5.9)	
Agricultural land:	1260	*	* together (5.9)
Transport:	360	*	
Others:	601	*	
Total:	21461	(6.4)	

Sources: SVT XVII A: 12; STV 1978; SVT III: 78; SVT XVIII A: 102; Huttunen 1981; Karjalainen & Tykyläinen 1981; Pohjois-Karjalan seutukaavaliitto 1984a.

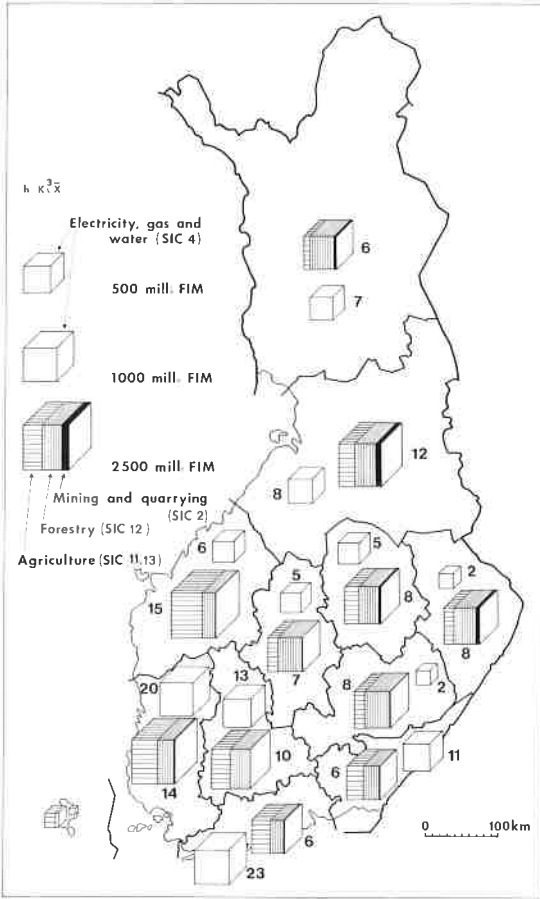

Fig. 13. Value added in the primary and energy sectors of the economy, by branches of activity and provinces. The figures indicate the percentages of the total value added for Finland accounted for by each province (Regional accounting 1980).

country as a whole and very much more than in the south of Finland. Milk production has been limited in recent years by means of production ceilings and efforts have been made to persuade farmers to move out of this branch of farming.

Specialization in vegetables, fruit, etc. is highly restricted in Northern Karelia on account of the production costs involved, especially in terms of the climatic disadvantages of the region compared with the south of the country and the longer distances to major markets. There are evident advantages, of course, such as the very low level of soil and air pollution as compared with parts of Central Europe, but these are not unique. Some efforts have been made to find more profitable lines of production (e.g. for

farming, berry cultivation), but skilful, efficient farm management is required for the adoption of new lines of production and the opening up of new markets (widening the spatial margins: e.g. Smith 1981: 111—115). The excess capacity and existing infrastructure would make it possible to increase agricultural output, but a profitable selling price for products from Northern Karelia would be well above international price levels in the traditional lines of production. Since Finland's agricultural policy is geared to meeting national needs, the role of Northern Karelia has remained at that of a part producer of this balanced, planned national supply of agricultural products.

In forest products Northern Karelia is mostly a primary producer. Forestry and the wood processing industry are of considerable importance locally, especially since they make up such a large proportion of the region's exports, 56% in 1975, but its wood processing plants are of minor significance on a national scale, accounting for only a small proportion of total production, being concentrated at low levels of processing and involving only very small-scale production of actual woodpulp. Full commercial benefit can be extracted from wood processing only by exploiting the internal and external economics of the industry (the economics of scale, use of by-products and waste, etc.). These benefits are well utilized by companies operating on the southern part of the Saimaa watercourse, but these lie outside Northern Karelia, a considerable proportion of the country's wood processing industry being located in the province of Kymi in the south-east (Fig. 14). At the same time the forestry and wood processing carried on in Northern Karelia itself is tied to competitive international markets, where production units are becoming larger and being rationalized all the time. Without substantial new investment, the factories of Northern Karelia will be left behind as small, poorly intergrated units.

The role of the processing of renewable natural resources is an important one in Northern Karelia, as it is in peripheral areas in general in Finland, but again the significance of the peripheral areas on a national scale declines at progressively higher levels of processing. Thus the production of foodstuffs is dominated by factories in Southern Finland, while the centre and north of the country are largely suppliers of butter, cheese and milk powder. Similarly the provinces of Häme and Kymi are responsible for about a third of Finland's total production of

woodpulp and paper, and are therefore the most significant production areas in this field from the point of view of the nation's economy (Atlas of Finland 1983: 4–15).

Mining has been an activity of some importance in Northern Karelia, and one in which the region still accounted for a high proportion of national production in 1980 (Fig. 13). As is typical of a peripheral region, however, the only benefit felt locally was in the form of the wages obtained, for the further processing of the ores and extraction of the metals took place primarily in Southern Finland, to the extent of some 72% (Atlas of Finland 1983: 15). Peat reserves have been brought into use since the rise in fuel prices, and in this field Northern Karelia is well placed as it has fairly abundant reserves with a much longer predicted lifetime than in the case of metal ores. The region also has plentiful supplies of other resources such as gravel and water.

The proportion of the country's electricity and heat supplies generated in Northern Karelia in 1980 was 1.8% (SVT XVIII A: 101 I), a figure which comes close to its proportion of the value added in industry, 1.9%, but is well below its share of the whole country's population or labour force. Almost 9/10 of the electricity generated in the region in the 1970's was from hydroelectric power stations, and the region was responsible for only 2% of the country's total industrial consumption of fuels in 1981 (Pohjois-Karjalan seutukaavaliitto 1984a). The largest power station in the region is capable of generating 52 MW, only a fraction of the capacity of the large nuclear and coal-fired power stations in Southern and South-Western Finland. Again as much as 2/3 of the country's supply of electricity, gas and heat energy is located in the provinces of Uusimaa, Turku and Pori, Häme and Kymi (cf. Fig. 13).

The fuel budget for Northern Karelia shows a heavy dependence on fossil fuels:

oil + hydroelectric power + peat (consumption in the region) + wood and wood residues + black liquors + imported electricity = use in: industry + transportation + domestic heat and light and other consumption + losses and unknown

1985 (Twh): $3.0 + 0.7 + 0.2 + 1.3 + 0.5 + 0.4 = 2.0 + 1.1 + 2.7 + 0.3 = 6.1$

2010 (Twh): $3.2 + 0.8 + 0.9 + 1.4 + 1.0 + 1.1 = 3.3 + 1.7 + 3.1 + 0.3 = 8.4$

(Pohjois-Karjalan seutukaavaliitto 1984a: app. 2.2 and 2.5).

The consumption of peat as a fuel is expected to increase most in percentage terms over the period 1985–2010 (+350%), while the use of imported electricity and black liquor is also ex-

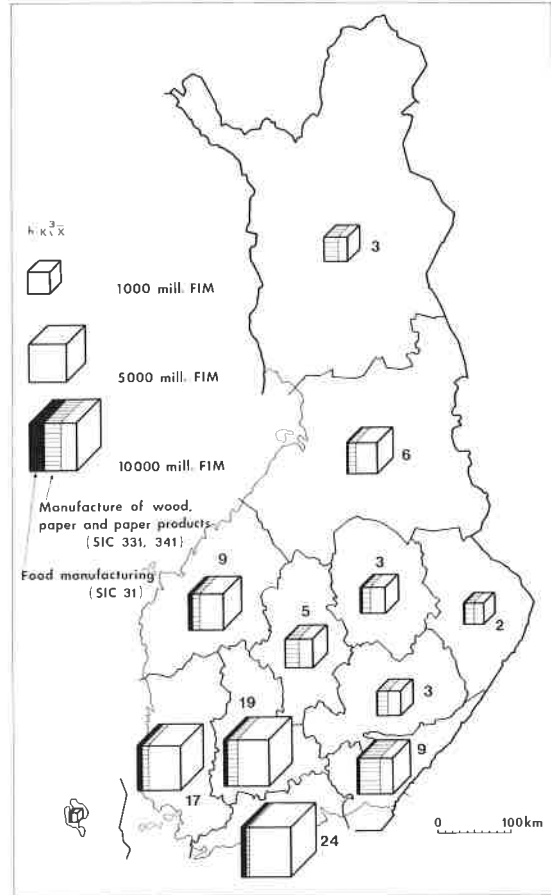

Fig. 14. Value added in manufacturing (SIC 3), by industries and provinces. The figures indicate the percentages of the total value added for Finland accounted for by each province (Regional accounting 1980).

pected to exceed present levels, although a doubling in the amount of the latter used for fuel purposes naturally also presupposes an increase of a similar scale in the manufacture of chemical

pulp in the region. The fuel budget calculations assume the largest increases in power consumption to take place in industry (+65%) and transportation (+55%).

Local fuel resources are potentially fairly good in relation to power consumption, especially since the aim is to increase the output of peat many times over in the coming years. As it is, peat production in 1978 was only 560 000 cubic metres, of which 4/5 was exported from the region and 1/5 used locally, whereas by 1980 production had increased to approx. 1 mill. cubic metres, of which 600 000 cubic metres was exported to South-Eastern Finland. There is also an annual source of additional fuel in the form of logging and silvicultural waste, the energy content of which is equivalent to that of all the fossil fuels burned in the region each year. This potential is not taken into account at all on the supply side of the above fuel balance equation.

It should be noted that the region's history contains many examples of changes occurring in the exploitation of natural resources, including the draining of certain lakes, changes in agricultural technology, and the use of peat and lake ores, etc. (see Pulliainen & Eskelinen 1978; Saloheimo 1977). Technological advances, changes in the structure of consumption, and changes in relative price levels, etc. are matched by alterations in the system of industrial production, which in turn affect core-periphery relations. These changes concern the exploitability of the resource base and relations between the various branches of industry.

Materials flow analysis

Economy-environment relations

The production of goods and services is principally directed by market forces, which are thus mainly responsible for changes in production and for the input of natural resources required. When an economy is examined in terms of the use and cycling of materials, with full account taken of the utilization of natural resources and the generation of waste, this requires a treatment which is broader in kind than that presupposed by traditional economics (Eriksson 1979: 11—13, 65—73). Even so, not all natural resources can be assigned a value by reference to market forces, for some, such as natural water supplies, are classed as freely available commodities. It is the supply of natural resources, however, which the economy uses to produce goods, and it is in this production process that waste is generated, the latter being relevant to the market forces insofar as it can be utilized or recycled for produc-

tion purposes or its disposal, by returning it to nature, entails a cost element. Thus production involves certain factors, such as free commodities, waste, etc., which can be included in the description only by taking them into account as physical entities.

We shall limit ourselves here to examining from the viewpoint of regional economic transition and core-periphery relations the position which each region to be studied occupies in the spatial division of labour as a utilizer of natural resources and a producer of various effects upon the natural environment and the manner in which that region can develop in relation to the opportunities afforded by its natural resource base (Fig. 6). The extent to which natural resources can be exploited is crucially dependent on the market prices of raw materials, and thereby upon world markets in the majority of cases. Changes on world markets are reflected in the demand for staple products, and thereby impinge on peripheral economies, along with their many economic and environmental consequences. The roles of the various natural resources in the production and exchange of goods are of significance for any long-term evaluation of such effects, whereupon their exploitation is governed not only by economic considerations, e.g. prices or available technology, but also by the conditions regulating the renewal of flow resources and the need to optimize the consumption of stock resources as a function of time. Renewal can be influenced by human agency, e.g. in improving timber production in forests, while the reserves of stock resources are determined by price levels and questions of technology (see Brobst 1979: 112—119). The annual production and stock levels of natural raw materials thus have a direct effect upon the opportunities for exploitation, and thereby upon the regional economy, while on the environmental deterioration side it is a question of the waste loading and damage caused by the processes of production and consumption.

Flows of matter and energy are regulated by the laws of physics and the economic system. Analysis of the handling of matter and energy occasioned by economic activity, i.e. in the various stages of economic processes, may therefore be used to formulate a system of material and energy inputs and outputs in relation to the economy and the natural environment. This leads us to a mass balance approach involving the study of mass budgets and cycling (Douglas 1981) or a materials balance approach (see Ayres & Kneese 1969). Approaches of this kind may be referred

to in general as forms of materials flow analysis.

The analysis of systems of physical stocks and flows has traditions of its own, and has been applied in physical geography to describe cycles in the geosystem, for instance (e.g. concepts of water balance, radiation balance, the sedimentary cycle, the nitrogen cycle, etc.; see Strahler & Strahler 1978), and also in forest inventories, and its principles are similarly evident in many other analyses of physical systems (for example, see Huggett 1980). Materials flow analysis has also been applied to regional studies (Jansson & Zucchetto 1978; Douglas 1981), being available for use at the regional or urban level to deal with such things as efficiency, location, core-periphery relations, urban hierarchies in production and regional self-sufficiency or dependence. Such an approach can also be adopted for the analysis of resource use in peripheral areas.

The present materials flow analysis is restricted to the examination of material connections within a peripheral area (Fig. 6), being concerned with the major flows of materials in Northern Karelia, for even these require the processing of a very considerable body of data. Where applicable, the results are then compared with material and energy data for other parts of the core-periphery system. The functions involved in this peripheral economy are divided into sectors, with the exploitation of natural resources forming one such sector, labelled *utilization* (Fig. 6). This in turn consists of the characteristic primary production sectors, agriculture, forestry and mining (SIC 1—2), and industries such as water supplies and the production of electricity and steam (SIC 4). Natural resources enter the economic cycle principally through the agency of the utilization sector, from which they are transferred to the *processing* sector, comprising the manufacturing industries, and finally to the *consumption* sector, after which they pass to waste disposal or are returned directly to nature. As indicated in Fig. 6, not all flows of resources pass through the utilization sector, but some pass into direct use, e.g. water, and correspondingly some of the waste is transferred back to the environment directly from the various sectors without further treatment. Most flows of this type, especially the direct waste flows, are cost-free to the producer, but are included in the present analysis as they are evaluable in terms of quantity at least. The approach adopted here thus follows the principles of analysis in terms of physical units employed in resource and materials ac-

counting (Laihonen 1972; Ayres 1978; Resource accounts 1981; Tykkyläinen 1984).

The purpose of the model set out below is to provide a general impression of resource use and waste generation in a peripheral economy and the degrees to which these functions are focused upon local utilization and exportation. It therefore represents an attempt to outline the distinguishing characteristics of production and material exchange in the resource periphery of a spatial economic system by means of materials flow analysis.

Modelling the system of resources, goods and waste

There are a number of models suitable for analysing the relations between an economy and its physical environment, one of the most familiar of which is the economic-ecological input-output model. Variations exist in the application of this method (see Victor 1972; James et al. 1978), but it enjoys the considerable advantage compared with purely physical calculations or cyclic schemas that it preserves throughout its direct conceptual and mathematical connections with a monetary analysis of the same regional economy. The model is constructed here from data describing the utilization of natural resources and the production of waste combined with a regional input-output model.

The model is based on coefficients for natural resources, goods and waste in particular branches of the economy, which are then used in an input-output model restricted to deal only with the analysis of material and energy flows in the periphery. The matrices and vectors employed are:

- R = resources supplied by the primary production sector (SIC 1—2 and 4), imported resources and free commodities obtained by industries per unit of total output, and resources utilized by primary production for maintaining this supply per unit of total output,
- R' = matrix of resources utilized by primary production to meet final demand only, per unit of final demand,
- W = matrix of waste matter generated in production processes but not reused, per unit of output. In pollution abatement only the waste caused by maintaining the processes is accounted for.
- G = final products per unit of final demand,
- A = matrix of input coefficients,
- I = identity matrix,
- x = vector of total output by industries
- y = vector of final demand by industries

The elements of matrices R , R' , W and G denote amounts (e.g. in tonnes) per monetary unit (e.g. Finnish mark), while A describes inputs into intermediate products (in FIM) per unit of total output (in FIM), and the vectors x and y are also expressed in monetary terms (FIM). Examples of the content of the matrices and the equations for the models are provided in Appendix 1, and the classifications used here for natural resources and waste in Appendix 2.

The symbols R , R' and W stand for mutually exclusive resource and waste flows, on the assumption that the division of resources into two categories, R and R' , and the introduction of waste before treatment will give a description of ecological and economic processes which is more precise than the numerical data for an input-output model alone (cf. Herendeen 1974).

The regional input-output model yields the following balance in resource use:

$$(1) \quad Rx + R'y = R(I-A)^{-1}y + R'y$$

Equation 1 reminds us that resources introduced into the production process must also be tied up in the final product. The product of matrix R , the matrix of direct coefficients, and the inverse of $(I-A)$ shows the direct and indirect use of resources per unit of final demand. This forms a matrix of cumulative coefficients and is marked by the symbol R° . The coefficients R' serve to denote direct supplies. The total coefficient R'' is obtained by summing as follows:

$$(2) \quad R(I-A)^{-1} + R' = R''$$

The inclusion of matrix R' in the matrix of cumulative coefficients ensures that direct supplies from the primary sector are also taken into account in the final results.

A proportion of the resources will be transformed into waste, the output of which is:

$$(3) \quad Wx = W(I-A)^{-1}y$$

The industries processing the resources add a corresponding loading of waste to the final demand in accordance with the proportions to which they take part in the production process as suppliers of intermediate products and producers of final products. Thus the quantity of waste produced by industries is equal to the waste loading attached to the final demand and the whole of the economy. For simplicity:

$$(4) \quad W(I-A)^{-1} = W''$$

The elements of W'' are known as cumulative coefficients. Direct coefficients are unnecessary

in the case of waste, as no such process exists, and therefore the total coefficients are identical to the cumulative coefficients.

The principle of materials balance can also be expressed simultaneously in the input-output approach, in terms of resources, final products and waste. Let G = final products per unit of final demand. We then assume that recycled wastes are internal to the economic process (otherwise they could be regarded as both resources and wastes), so that for the whole economy it is true that resources = final goods + waste. The materials balance formula obtained by the input-output approach is therefore:

$$(5) \quad \Sigma R(I-A)^{-1}y + \Sigma R'y = \Sigma W(I-A)^{-1}y + \Sigma Gy$$

It is also possible to use Rx instead of $R(I-A)^{-1}y$. Equation 5 is true in a closed economy, but an open economy requires the inclusion of imported intermediate products in the equation. The data problems involved in empirical applications are formidable, and thus the balances are difficult to account for.

The common problem with materials flow analysis is that accurate information from the statistical sources is not available at all points in the model. In the present case some of the necessary data are given in Karjalainen & Tykkyläinen (1981), and these are filled out from other statistical sources, handbooks, etc. The amounts of waste generated in agriculture and forestry are estimated from the corresponding data available for these branches of the economy in Sweden (*Resursflöden . . .* 1975). The economic input-output model itself was constructed by Eskelinen (1980).

The materials flow approach gives a detailed analysis of resource use and conversion and of the production of goods and waste in the economy. Theoretical analysis of the utilization of natural resources could then be continued by developing different kinds of balances and measures of efficiency and self-sufficiency based on information derived from accounts and input-output analyses. This is done to some extent in the empirical part of this work, representing applications of the basic equations 1–5 from the model outlined above.

Resources and waste in a peripheral production system

The economy of Northern Karelia may be divided into 29 sectors, four categories of natur-

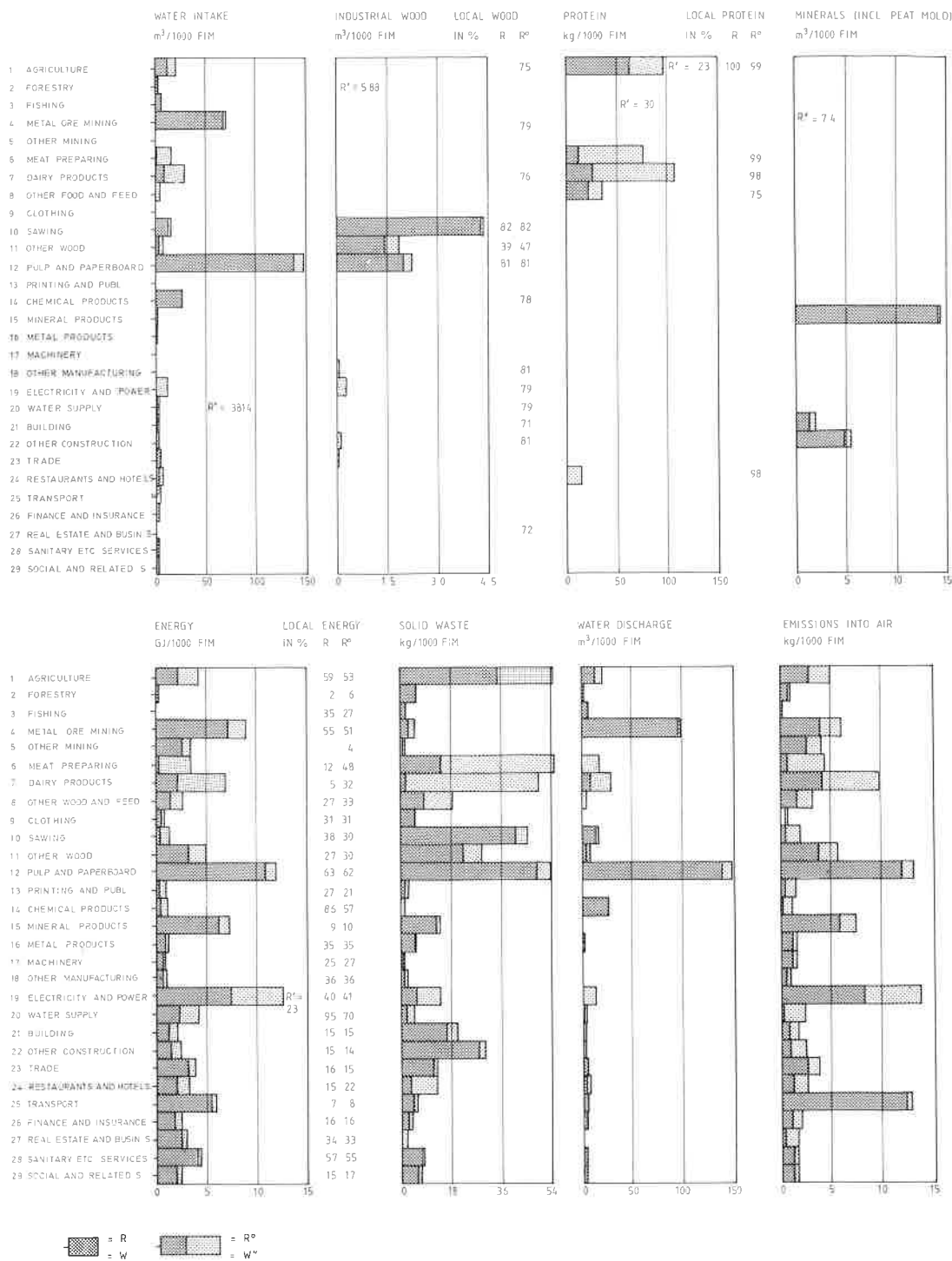

Fig. 15. Resource use and waste generation in the industries of Northern Karelia (direct R, W; cumulative R°, W°; direct supplies R'). Minerals include peat. Emissions into the air comprise sulphur dioxide, nitrogen oxides, carbon monoxide, hydrocarbons, lead and particles from vehicles and sulphur dioxide and particles from other sources.

al resources, one energy category and three categories of waste (Fig. 15). The resource and waste categories are presented in Appendix 2. The loading of the natural environment caused by production may then be investigated by means of the materials balance model described above.

R in Fig. 15 indicates the extent to which each branch of the economy utilizes natural resources for every 1000 FIM value of total outputs, i.e. its resource input for further processing. The symbol W then stands for the waste generated by the same branch (relative to the total output). The calculations of natural resources used per total output (R) involve assignment of resource inputs to the various branches of the economy as used by these, while those resources consumed directly by the households or exported from the region without processing (R') are assigned to the final demand.

The cumulative coefficient R° describes the extent of the natural resources which go to meet a final demand of a value of 1000 FIM in the branch of the economy in question, and also in other branches via intermediate products generated at various stages, while W'' correspondingly denotes the volume of waste resulting from various stages in the manufacture of final goods to a value of 1000 FIM. R' (i.e. the matrix of direct supplies) indicates the extent to which the branch in question (primary production, electricity or water services) supplies natural resources directly to meet the final demand per 1000 FIM value of this demand. Thus by taking the sum of R' and R° we obtain the total coefficients describing the utilization of natural resources with respect to the final product. The symbol for total waste generated with respect to the final product is W''. When comparing the coefficients, it should be remembered that the (direct) physical quantities in matrices R and W are expressed per total output whereas those in the other matrices (direct supplies, cumulative and total) are expressed per final demand (Fig. 15).

The above data do not include silvicultural and logging waste, waste rock in the mining of ores or water discharged from pools in fish farming (Fig. 15), nor do they take account of manure etc. used as a fertilizer in farming. Also excluded are imported intermediate commodities with the exception of fuels, wood and other resources of a negligible degree of processing. As may be seen from the diagram, however, emissions of waste into the air are included, reducing the weight attached to emissions from sources other than vehicles.

As shown in Fig. 15, flow resources appear to be bound up in the final products of branches 1—8, 10—12 and 19—20 of the regional economy of Northern Karelia and stock resources in those of branches 15 and 21—22. These comprise groups of industries connected with agriculture, forestry and minerals which principally process natural raw materials and generate waste. The natural resources upon which they rely are chiefly local in origin, and although some wood is brought in from elsewhere, it is negligible in amount compared with the round timber exported from the region. In addition, mining, the construction industry and the manufacturing of mineral products play a considerable role in local resource use. Local water resources are adequate to satisfy the industrial and domestic demand. There is no appreciable loading of waste products or use of energy in industry beyond these extractive and processing industries.

The proportion of total energy consumption met by local primary sources varies greatly from one sector of the economy to another, the majority of the variation being explicable in some cases by the choice between electricity and fossil fuels, and also to some extent by the use of wood, waste wood and black liquor as fuels. The fuel figures for this region seem to fit quite well with the national ones (Mäenpää et al. 1981), except in the case of sector 27, where fuel used for domestic heating is not included in the present calculations.

The total coefficients for energy and water consumption deviate markedly from the distribution of the figures representing purchases from the electricity generation and water supply sectors in the inverse matrix, the correlations between these and the cumulative coefficients (R°) being .287 for the power demand and —.073 for the water demand. Since consumption within the supply sectors themselves is ignored, the deviations must arise from price differentials and by-production of power and water in many industries. Of these, the price differentials are included as such in the coefficients of the inverse matrix, while factories' own water supplies, use of fuels and associated power generation are not taken into account in the distribution of the total electricity and water supply inputs as depicted in the inverse matrix.

The considerable variations found in the direct, cumulative and total coefficients impose limitations on any statistical analysis. The spread of cumulative effects through the economy and the nature of these cumulative effects are studied here by calculating coefficients of variation for

Table 4. Coefficients of variation (standard dev./mean).

	Direct	Cumulative	Total
Minerals	4.0	3.6	3.0
Protein	3.1	2.6	2.4
Industrial wood	3.3	3.0	2.7
Water intake	2.5	2.0	4.8
Energy	1.1	0.8	1.4
Solid waste	1.2	1.1	1.1
Water discharge	2.5	2.1	2.1
Emissions into air	1.3	1.0	1.0

the material (Table 4).

Mineral resources are used only in a few industries and are poorly distributed in the final demand, ores being mainly exported from the region and gravel production being represented chiefly by the final demand figures for the construction industry. The coefficients of variation for proteins and industrial wood supplies are fairly similar, even though the industries utilizing these are entirely unrelated. The direct suppliers of protein are located in two sectors, agriculture and fisheries, whereas forestry is the only direct source of wood. Even so, the addition of direct supplies to the cumulative coefficients does not appreciably alter the distribution of protein in terms of final products, the coefficient of variation attached to the total coefficients being practically as high as that for the cumulative coefficients. The fact that the coefficient of variation in the total coefficient for water consumption is very much higher than that for the generation of waste water is a result of the supply of water for direct consumption, since waste water here includes only that generated in the course of industrial production.

Natural resources and waste can be further divided into general types and those specific to individual branches of the economy on the basis of the scatter properties of their final demand distributions (Table 4; Fig. 15). Minerals, industrial wood supplies and proteins are industry-specific resources in terms of production, and cumulative effects cause only a minor dispersion beyond the bounds of their exploitation and processing chains, whereas water intake and discharge is more general in nature but at the same time specific to certain processing industries and power supplies are the most evenly distributed of all, constituting a true general input to the economy of Northern Karelia.

Waste appears to be distributed more evenly than are material resources, solid waste and emis-

sions into the air being the most general forms of output, while greater variations are seen from one branch of the economy to another in emissions of waste water.

The resulting total coefficients now furnish a means for aggregating industries on the grounds of their specific utilization of natural resources and generation of waste. Here the economy of Northern Karelia divides into two parts: 1) industries based on local resources, sectors 1—8, 10—12, 15, 19—22 (Fig. 15), and 2) industries functioning independently of local resources, the other sectors. The *resource-based industries* are those in which the use of local natural resources plays a significant part in meeting the final demand and the *resource-independent ones* those in which those that require, directly or indirectly, very little in the way of local resources. The latter, often 'new' industries, naturally require a certain input of power and water, for instance, but this is of negligible importance in relation to resource use and waste generation within the province as a whole.

New industries to Northern Karelia constitute one sub-group of the resource-independent industries, comprising sectors 9, 14 and 16—18. The term new industry is naturally tied to a given time and place, and is used here to refer to a stratum in the industrial picture for Northern Karelia which expanded rapidly in the 1970's, is independent of natural resources and chiefly markets its products in areas outside the region (Appendix 3). This class of SIC-3 industries showed a 321% increase in its labour force in the region between 1970 and 1978, compared with an increase of 10.5% in other industries (SVT XVIII A: 92, A: 99).

In the case of industries in the resource periphery it is thus the final demand for products and the resulting volume of production that determines the extent to which natural resources are exploited and waste generated. By multiplying the

Table 5. Local resource and waste components of final demand in Northern Karelia. Percentage, volumes, and waste generation per man-year.

	Percentage contributions						Per man-year		
	Local resources				Waste			Waste	
	1.	2.	3a.	3b.	1.	4.	5.	ktonnes	tonnes
1 Primary prod.	23	40	59	34	26	17	18	.724	.6
2 Resource proc.	54	14	38	5	61	48	48	6.522	6.9
3 Other industries	2	.	.	.	2	1	1	.306	.3
4 Power and water	7	.	.	.	1	1	1	.652	1.4
5 Construction	8	44	1	58	4	19	21	.287	21.1
6 Services	6	1	2	1	6	12	10	.227	.6
Total volumes in 1000 weight tonnes (ktonnes)	68 164	8 848	2 191	6 657	57 555	78	66		

1. = total, 2. = minus water intake. Without water intake: 3a. = renewable resources, 3b. = nonrenewable resources. 4. = wastes minus water discharge, and 5. = solid wastes. Aggregation of industries: 1 = 1+2+3+4+5, 2 = 6+7+8+10+11+12+15, 3 = 9+13+14+16+17+18, 4 = 19+20, 5 = 21+22 and 6 = 23+24+ . . . +29.

total coefficient matrices by the diagonal final demand matrices, we obtain matrix D, representing figures for the combined amounts of natural resources employed at the various stages in the manufacture of the final products by resource type and branch of the economy, together with the corresponding matrix H for the generation of waste by waste category and branch of the economy (equations 6 and 7). These results can then be aggregated by sectors of the economy or classes of resources or waste. Before aggregation, the quantities may be expressed by

$$(6) D = R'' \hat{y}$$

$$(7) H = W'' \hat{y}$$

where \hat{y} is a diagonal matrix representing final demand in the various branches of industry.

The percentage distributions indicated in Table 5 are obtained by calculating the resource and waste components in the final demand for individual sectors of the economy (equations 6 and 7), and aggregating the results to form six classes of industry, each with its percentage contribution indicated, together with a total figure for local resource use and waste generation in all industries, expressed in tonnes (Table 5). Here local wood includes that used for fuel purposes and local agricultural resources, expressed in tonnes, are quoted instead of protein content (cf. Fig. 15). The inclusion of imported natural resources (timber, cordwood, fuels, cereals, etc.) will scarcely alter the distribution at all (Table 5),

since these are equivalent to only about 4% of the local resources except in the case of water (Table 7).

The results present a distinct picture in which the resource-based industries of the area are responsible for both a substantial exploitation of the local natural resources and also a higher than average loading of the environment with waste (Fig. 15). If we also bear in mind the proportion of total industrial output in the regional economy accounted for by these branches, we see just how dominant a position they occupy in resource use and waste loading in the area (Table 5).

The resource component of the final demand varies from one resource group to another, but almost all local resources and waste types are entailed in the commodities generated by primary production and the constructional and manufacturing industries, sectors which accounted for 41% of the value added in the regional economy in 1975 (sectors 1, 2 and 5 in Table 5).

The results also show the significance of water as a prerequisite for industrial production, since this makes up 90% of the total flow of natural resources in the economy. Once water is excluded, it is also evident that the exploitation of stock resources is three times that of flow resources by weight, even though in terms of employment effects the manufacturing industries of the region are concentrated more on the processing of renewable resources than of non-renewable ones, a feature which is probably of benefit as far as long-term utilization is concerned.

The distribution of waste generation is somewhat more even than that of resource use, although this partly depends on one's definition of waste. Waste from primary production would be very much larger if all residues were taken into account, for instance, since the waste rock generated in mining operations (2 mill. tonnes/yr) and the felling and logging waste in forestry operations (just under 1 mill. tonnes/yr) represent very substantial amounts of material compared with the total solid waste produced and sent for disposal in the manufacturing industries of the region (66 000 tonnes/yr). Even these, however, are equivalent to only about 5 % of the waste water emitted by industry. The construction sector is interesting from this point of view, however, in that the solid waste it generates includes heavy materials such as cement, gravels, mineral residues, etc., whereas its output of waste water per man-year is even lower than that in the new industries, which would entitle it to be regarded as a branch of the economy which is independent of local natural resources.

Waste loading per man-year is greatest in the resource-processing sector, whereas that in the new industries reaches only 1/20 of this level. This implies that if economic development in the region proceeds in the direction of the newer industries (sector 3 in Table 5) the resulting increase in environmental loading will be substantially slower than that in total industrial production. This would be one somewhat roughly expressed but nevertheless clearly discernible environmental consequence of the strategy which favours the development of new industries.

The above figures also show some links between resource use and waste generation. There are evidently three ways in which pollution and resource depletion can be reduced: 1) technological progress, 2) pollution abatement, and 3) changes in the production mix in the economy. Technological progress implies the achievement of increased output with a smaller resource input and/or lower production of waste, while a pollution abatement policy can alter the nature of the waste produced but does not affect the material efficiency of the economy. Changes in the production mix, i.e. in the structure of the economy can have far-reaching repercussions in that trends in the resource-based industries in Northern Karelia have usually determined to a considerable degree the nature and extent of environmental loading in the region.

Although it is the resource-based sector of the region's industry that is responsible for about

9/10 of the waste generated, this observation as such does not suffice to tell us whether there is any one particular resource category whose exploitation and processing dominates waste production in the economy as a whole or any one component of this. This question may be examined by means of a correlation analysis based on the total and cumulative coefficients R'' , R° and W'' (Fig. 16). Such an analysis can also be expected to indicate to what extent the various natural resources are transformed into final products of the same branches of industry (correlations between resource categories). The correlations between the waste categories in turn denote the extent to which the various waste components (solid waste, waste water, emissions into the air) vary in a parallel manner from one sector to another as elements of final demand (Fig. 16).

Certain large items exercise a considerable effect on the results, especially where product-moment correlations (r values) are concerned (Fig. 16). For example, exports of primary products and household power and water supplies are included in the calculations of total coefficient correlations, but although quantitatively large, these do not give rise to any appreciable waste loading because of the low level of processing involved. If such direct supplies are not taken into account and the product-moment correlations are calculated from the cumulative coefficients, the correlation coefficients will be much higher (Fig. 16). This latter approach provides a better picture of the correlation between resource use in the processing industries and waste loading.

The correlations between the resource categories are mostly low, suggesting that different resources are processed by different industries to meet their respective final demands. Most manufacturing processes employing natural raw materials are indeed specialized to make use of natural resources of just one specific type throughout their production chain, so that the cumulative process does not transmit different natural resources for use in the final products of the same sector to any appreciable extent. Similarly it is not possible to point to any resource category transmitted to final products which exercises a dominant influence over the distribution of waste generation. On the contrary, greater significance can be assigned to the results which point to mutual correlations between the categories of waste (Fig. 16). In terms of the rank correlation results a good predictor of waste

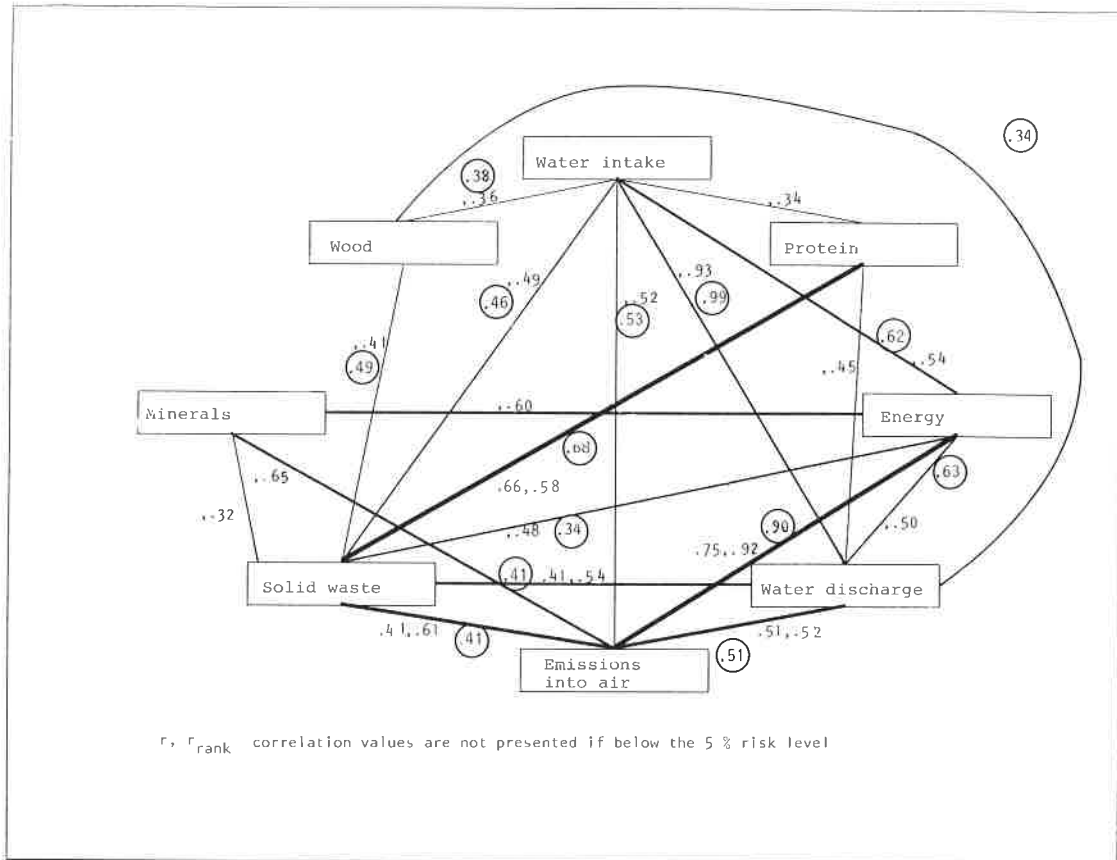

Fig. 16. Correlations between resource uses and waste generation in Northern Karelia (total coefficients). The product moment correlations in circles are calculated from the cumulative coefficients. The thicker the line is the more significant is the correlation between the categories.

production would seem to be a high power input.

If one were to disaggregate the resource classification and group the waste in accordance with its resource origins, powerful dependency relations would emerge between resource use and the resulting generation of waste. Thus the products of the wood processing industry, for example, entail the creation of significant quantities of solid waste, but the correlation between industrial wood supplies and solid waste is low because the waste generation figures per unit of final product also include waste from branches whose final products do not require any direct or indirect input of industrial wood (Fig. 16). The correspondence between resource and waste categories is most in evidence in the case of power generation and air pollution. The above correlation analysis nevertheless gives an impression of

dependency relations at the level of the whole regional economy, although the analysis of the detailed dependencies requires in itself a knowledge of the materials balance situations for the various sectors and their final products together with their disaggregated resource and waste categories.

Material efficiency by commodities is investigated here by developing indicators to describe the relation between waste production and resource utilization (equations 8 and 9). Here all resources and waste are expressed by weight in tonnes, and the figures for agricultural and wood resources are used rather than those for protein and industrial wood. The calculations include imported natural resources, although they are of little significance for the results, but exclude material inputs arising from the importation of advanced manufactures as intermediate products

Table 6. Waste as a proportion resource input in Northern Karelia (1975). Exports and imports per total output.

Sector:	Direct		Embodied		Exports/ total	Imports/ output
	Total	*)	Total	*)		
1 Primary production	90	.	91	.	.354	.121
2 Resource processing	96	2	96	3	.601	.247
3 Other industries	98	29	98	13	.734	.392
4 Power and water	1	24	10	5	.	.069
5 Construction	.	.	10	.	.	.325
6 Services	98	12	97	7	.	.127
Total 1—29 industries					.272	.197

Aggregation of industries: 1 = 1+2+3+4+5, 2 = 6+7+8+10+11+12+15, 3 = 9+13+14+16+17+18, 4 = 19+20, 5 = 21+22 and 6 = 23+24+...+29. *) minus water intake and discharge.

(e.g. machinery, equipment, etc.), so that they allow efficiency to be examined in terms of the waste produced in Northern Karelia as a function of the natural resources exploited and processed in the region. A second limitation is that emissions of waste into the air are not fully accounted for, as there remain small but important problems associated with changes in the moisture content of raw materials and waste, for example. Material efficiency is expressed in the following in terms of waste as a proportion of the resource input, distributed by commodity and sector of industry. The equations used are:

$$(8) \quad p_1 = (\Sigma \Sigma v(i,j) / \Sigma \Sigma t(i,j)) \times 100$$

$$(9) \quad p_2 = (\Sigma \Sigma h(i,j) / \Sigma \Sigma d(i,j)) \times 100$$

in which $V = W\hat{x}$, $T = R\hat{x} + R'\hat{y}$, $H = W''\hat{y}$, and $D = R''\hat{y}$.

Here p_1 denotes the direct waste component as a percentage of the natural resources used and p_2 the waste component embodied in the final product.

Since water intake and discharge make up a large part of the total quantities, waste as a proportion of resource utilization is calculated here both with and without the water contribution (Table 6).

The total figures serve to indicate that, with the exception of the water supplies and power generation sector (4) and the construction sector (5), the waste generated by industrial production is equivalent to at least 90% of the resource input into that production. This is due to the dominant role of water in the production processes (Table 6). The exceptions, sectors 4 and 5, arise from the fact that the water supplies sector transmits the water which it extracts for domestic use,

while the construction sector uses very little water compared with other materials.

The distributions of solid waste and emissions into the air (columns 2 and 4) differ markedly from the total figures (columns 1 and 3). The other industries are now seen to involve a higher output of solid waste and emissions into the air in relation to the resources which they use than do the primary and resource-processing sectors, and while the primary and resource-processing sectors are still responsible for the vast majority of the solid waste and air pollution generated (Table 5), although this waste is of little consequence in relation to their vast input of natural resources, even excluding water (Table 6). Thus the high contribution of primary production (and also resource processing) to waste generation in Northern Karelia (Table 5) is not the outcome of inefficient use of resources but of the size of these sectors and their extensive use of resources (provided one accepts this definition of waste).

The disaggregated division into sectors indicates that certain branches in Northern Karelia produce more waste than they consume natural resources, the reason for this evidently lying in waste from intermediate products and commercial goods. This is true of the solid waste and air pollution component per final product entailed in the clothing industry, for instance, once water intake is excluded. The trade sector similarly produces more waste than it uses resources, and the same effect is caused by the use of water in mining, where the excess of waste over exploitation is 6 %, since the mine water is not counted as a resource on the input side.

The results for resources and waste components embodied in final products point in the same direction as the direct figure, even though

the former figures for solid waste and emissions into the air in the other industries, water supplies and power generation and the service sector are slightly lower than in the direct calculations, due to the fact that the process of cumulative effects introduces quantitatively more resource inputs into these sectors than waste inputs, reducing the proportion of waste generated.

Economic activity in this region clearly involves a high throughput of water, reflecting the importance of water in the production processes. The production of many commodities with high resource and waste components is quite efficient in material terms if water is not taken into account, while others, e.g. services and some functions independent of local resources, even though the 'only' produce waste, can be shown to generate a negligible amount of this once water is excluded. The general rule seems to be that the more industry a peripheral economy contains which is engaged in processing natural resources, the greater will be the amounts of waste generated, even though these amounts may be small in relation to the resource input. The importance of these environmental effects for industry within the regional economy can be reduced by the introduction of new industries, while the material efficiency of the economy (waste as a proportion of resource input) can be improved by more intensified use of the raw materials involved in the production process or alterations in the product to enable its manufacture to generate less waste. It is also possible, of course, to purify the waste, but the essential point to be accepted here is that a considerable influence can be exercised upon environmental loading in a regional economy by adjusting the structure of that economy to favour new industries in contrast to resource-processing functions.

Resources in relation to exports, local consumption and investment

Agricultural production per inhabitant in Northern Karelia is above the national average, and resources such as wood, gravel and water are also plentiful. Thus the region is an exporter of many natural resources and resource-based products, which means in turn a dependence on outside markets, especially for wood products. But at the same time consumption and production in the region is dependent on imports, to the extent that in 1975 imported consumption goods

and investment capital amount to an equivalent of about a half of the region's exports. Taking into account imports for production purposes, this implied a balance of trade deficit in that year of 300 mill. FIM, or 27% of the region's exports (Eskelinen 1980). This deficit was exceptionally large, and may be attributed to the depression in world markets, but it also serves to demonstrate that Northern Karelia is dependent not only on commodities but also on the financing of production and consumption.

In order to provide an overview of the region's external trade relations, direct exports and imports, expressed as ratios of total output, are also indicated in Table 6. This ratio varies greatly from one industry to another, so that the classification of industries into six sectors used in this table is not strictly appropriate in this respect. Some of the primary producers, for example, act as suppliers to processing industries, which are the main exporters of local resources, and consequently the export ratio among the primary production group ranges from .997 for the mining industry to only .017 for agriculture, the latter being quite unrepresentative of the reliance of this branch on export demands, since a large proportion of its products are exported through the food processing industries. Wood processing is the main exporter in the second group, each of the three sectors of wood processing industries involved having an export ratio of over .75, while among the other industries printing and publishing are those which are most clearly oriented towards local markets.

Most open industries are resource-independent ones, and as may be expected, the service sector entails only imports, so that its production must be paid for from regional sources alone (or by means of subsidies). The transition in regional structure to resource-independent industries means the payment of increasingly large import bills. The export/import ratios in the various sectors are 2.9 for primary production, 2.6 for resource processing and only 1.8 for other industries (aggregations of industries as in Table 6). This pattern is also indicative of the charges made for local resource intakes.

The destination of the resources utilized, use of imported resources and waste generation with respect to export (e), local consumption (c) and investment (i) are given by the following equations:

$$(10) \quad r_c = (R(I-A))^{-1} + R'_e) y_e$$

$$(11) \quad r_{c+i} = (R(I-A))^{-1} + R'_{c+i}) y_{c+i}$$

Table 7. Destination of resource and waste loading in the industries of Northern Karelia.

	Proportion to		Total volume	
	export (e)	local use (c + i)	in ktonnes	%
Local resources:				
Water	.726	.274	51 881	87
Wood	.843	.157	1 429	2
Agricultural res.	.486	.532	542	1
Minerals	.440	.560	5 900	9
Peat	.434	.566	23	0
Total	.699	.301	59 775	1000
Subtotal excl. water	.515	.485		
Imported resources:				
Wood	.918	.082	137	46
Agricultural res.	.530	.470	14	5
Fossil fuels	.567	.433	148	49
Total	.726	.274	299	100
Industrial waste:				
Solid	.498	.502	56	0
Water discharge	.807	.193	50 046	100
Emissions into air	.534	.466	10	0
Total	.806	.194	50 102	100
Subtotal excl. water	.503	.497		
Values of final demand industries 1—29:	.430	.570		

$$(12) \quad w_e = W'' y_e$$

$$(13) \quad w_{c+i} = W'' y_{c+i}$$

The results are presented in Table 7, where the sums of local resources going to local use (c + i) and export (e) include goods supplied for further industrial processing and deliveries made to meet the direct final demand. The undistributed items of supply is not included, however, so that the total volumes fall slightly short of those calculated using the non-decomposed final demand vector.

It may be seen here that over two thirds of the water used in Northern Karelia in 1975 contributed to the manufacture of goods exported outside the region, in spite of the fact that the figures for water supplies include not only industrial use but also direct domestic supplies (Table 7). If the use of water by rural households not reached by

direct water mains, 3.3 mill. tonnes per year, is also included, the proportion of water used in manufacture for export falls by some 5%, to 68%, with a further 18% of all water intake being embodied in commodities produced and consumed locally and 14% used in urban and rural households.

The category 'wood' similarly includes both wood as an industrial raw material and as a fuel, a considerable proportion of the former being exported from the region directly, while minerals include ores, gravel and clay, of which the ores are delivered to places outside the region while the gravel and clay is used in local production, chiefly to meet the needs of local demand. Little peat was used in 1975, and the proportion exported to places outside the region has undoubtedly increased since that time. The majority of the imported natural resources end up embodied in goods exported from the area.

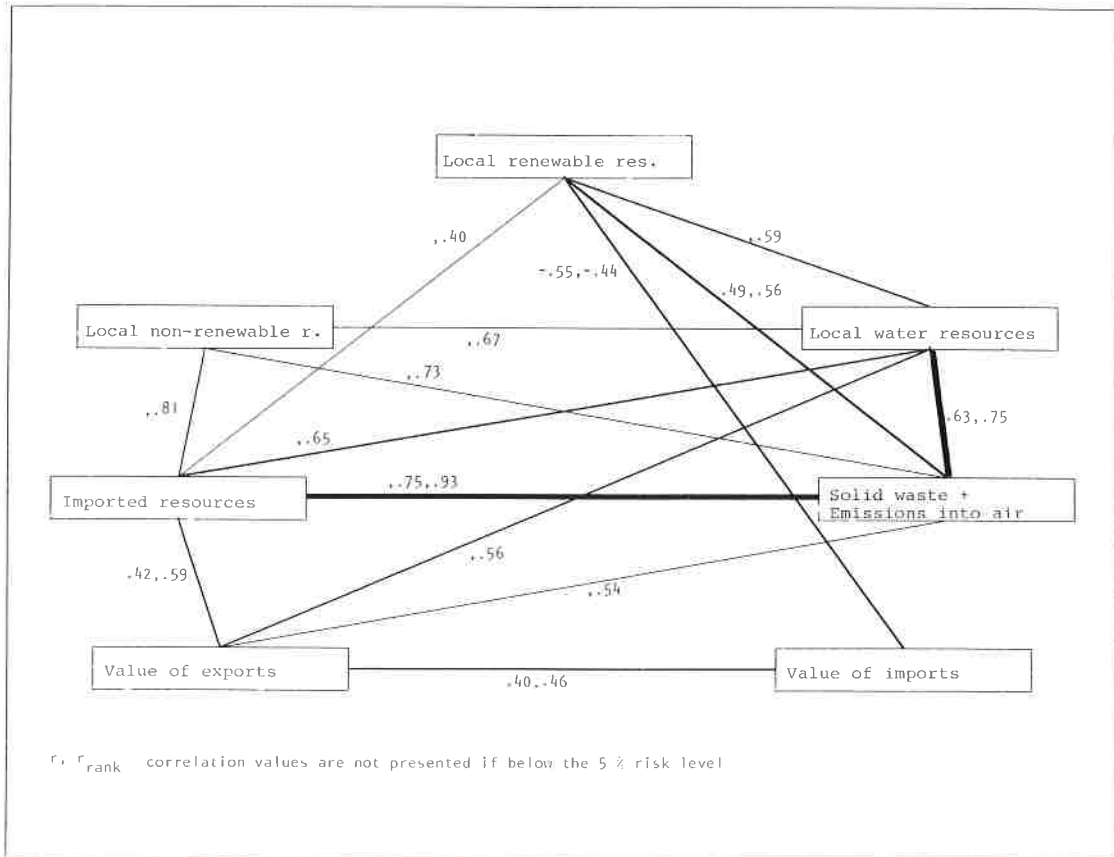

Fig. 17. Correlations in export structure in Northern Karelia. The thicker the line is the more significant is the correlation between the categories.

Although considerable amounts of fuels are used for domestic heating and transportation, the fossil fuels imported into the region for this purpose are not included in the figures for imported natural resources in Table 7. If they were, the resulting distribution of imported fossil fuels would be 76.3% for local consumption and 23.6% bound in the manufacture of goods for exportation from the region. Similarly the waste generation figures include only industrial waste.

The industrial use of wood and water constitutes the sphere of resource utilization which is most clearly geared towards production for export purposes (Table 7), these physical figures providing a more striking picture of the dependence of resource utilization upon external markets than do the export ratios for individual industries. The importance of an analysis of cumulative effects emerges in the case of the use

of water resources, of course, in that no untreated water is exported directly, but instead it is used indirectly for the manufacture of export commodities. Thus the processing of local natural resources for export implies at the same time a use of fuels and water for export purposes, and an associated production of waste, the choice of location for resource processing entailing an accompanying choice of site for 'direct' waste emission.

The dependence relation between waste generation and exports, imports and resource use is depicted in terms of the results of a correlation analysis in Fig. 17. Since only 18 industries in primary production and manufacturing are involved in exporting goods from the region, only these 18 are included in the correlation analysis. The data are based on resources and wastes involved in the region's export trade, i.e.

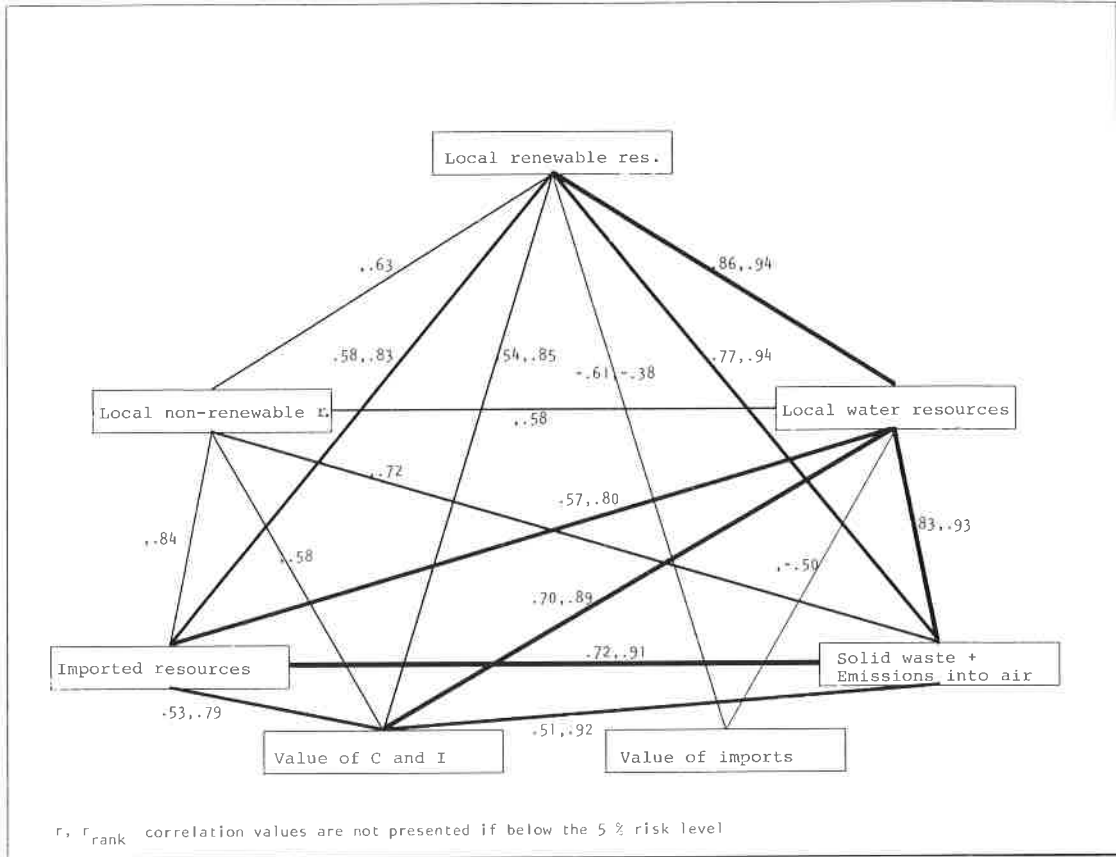

Fig. 18. Correlations in local consumption and investment structure in Northern Karelia. The thicker the line is the more significant is the correlation between the categories.

$$(14) \quad r^*(i,j) = k(i,j)/x(j)$$

$$(15) \quad w^*(i,j) = z(i,j)/x(j)$$

in which $K = (R(I-A)^{-1} + R'_{c}) \hat{y}_e$ and $Z = W'' \hat{y}_e$

The coefficients indicate the natural resources exported in the final products of each branch of industry per unit of total output and the amounts of waste generated in producing these items, attention also being paid to indirect influences exerted by other branches. Expression of the results in relation to total output serves to eliminate the effects of the size of the branch of industry concerned and allows the coefficients to be influenced only by the nature of the production processes and the composition of the final demand (i.e. the proportion of exports among the total final demand).

Fig. 17, representing the dependency relations

holding between natural resources and waste in the export trade of the province of Northern Karelia, shows the highest correlations to exist between waste and the re-exportation of imported natural resources and between waste and water utilization, while a good correlation is also obtained between waste and the use of local renewable resources for export purposes. An inverse relationship is noted between the value of imports and the exportation of renewable natural resources, however, suggesting that the sectors engaged in exports of products of renewable resources need only a small input of imported materials.

A positive correlation is seen between the values for imports and exports (cf. Table 6), with high proportions of both to be found in the chemicals, clothing, machinery and other manufacturing industries. On the other hand, the

value of imports is unsuitable as a predictor of the physical quantity of resources exported, the generation of waste or even the physical quantity of resources imported in the economy of Northern Karelia, an indication of the difference between the structure of imports and the physical quantities of natural resources exported, waste generated and resources imported. The exportation of natural resources and generation of waste in relation to final demand are based for the most part on the utilization of local natural resources, whereas the proportion of imported materials in the new industries in terms of value is very considerable.

The coefficients for exports of natural resources and waste generation in the service of exports, like the total coefficients (Fig. 15), contain certain pronouncedly high values, suggesting that the correlations are affected by certain individual resource and waste items. It is this that partly explains the low product-moment correlations.

Similar dependence relations can be tested between local consumption and investment patterns with respect to different types of resources and waste. This analysis was again performed using the 18 exporting branches of primary production and manufacturing, again eliminating the effect of the sizes of the branches by dividing the resources, waste figures or consumption values by the total outputs for the relevant branches (Fig. 18).

The overall correlation between the categories of resources and waste in local consumption and investment is higher than in the case of exports, presumably because consumption and investment do not involve such large quantities of pure resources going to meet the final demand (except for water intake), so that the distributions of the categories are in part more even. The absence of pronounced peak values serves in particular to increase the product-moment correlations. In any case, the local demand cannot absorb such large consignments of special products as can exports, and there are no semi-finished products involved in local consumption or investment. Thus, as seen in Table 7, the physical quantities for resources and waste are at a lower level in the case of local consumption and the use of investments. The multiplicative process is the same in both exports (e) and consumption and investment (c + i), but the difference in final demand makes the impact of local consumption and investment on the physical environment somewhat smaller.

Material and energy flows in the production system

Materials and energy in the industries of a resource periphery

Differences in focus exist between the provinces of Finland with respect to the exploitation of natural resources. The most agriculturally dominated provinces in 1980 were those of Åland and Vaasa, where agriculture accounted for over 2/3 of the value added in primary production as a whole, whereas forestry accounted for over 2/3 of the value added in Lapland, Central Finland and Mikkeli. The chief foci for the mining industry in that year were the provinces of Oulu (13% of value added in primary production) and Northern Karelia (12%). The corresponding figures for agriculture and forestry in Northern Karelia as proportions of total value added in the primary sector in 1980 were 29% and 59% respectively. Thus this province stood out up to the beginning of the present decade by virtue of the high production figures it attained in the mining sector, the product of which was greater in weight terms in 1975 than that of agriculture and forestry combined.

The production and processing of foodstuffs, wood processing and mining (with associated processing functions) together form a group of resource-based industries within the economy of Northern Karelia which stand out in terms of their dominant role in the utilization of materials and energy and their production of waste. The fact that the branches vary greatly in the intensity to which they utilize resources and generate waste, both in absolute terms and per unit of final product, does not render the economy of this region in any way exceptional, for major variations are customarily to be found between industries in these respects (see Suzuki et al. 1976). The crucial role of exploitation of local resources within the economy can be regarded as a typical feature of a resource periphery, where the question of what forms of exploitation become the most important is eventually decided by the nature of the resource base and the degree and type of specialization practised.

The dominant position of the resource-based industries as far as waste generation is concerned still implies fairly modest amounts of waste in relation to their resource input. It is in these industries, in any case, that the effects of cumulative processes are felt especially strongly, and any

changes in the exploitation and processing of renewable resources in particular will give rise, both directly and via these cumulative processes, to changes in the emission of waste.

The correlation between the various components of waste (waste water, solid waste and emissions into the air) and the use of power and water (excl. direct water supplies) denotes a certain link between different types of environmental loading and between these and the general intensity of materials utilization. Waste water is somewhat more specific to certain branches of industry and final products in this region than are solid waste and emissions into the air, due partly to the very much greater intake of water required for pulp manufacture and ore extraction than in other sectors.

Over a half of the utilization of natural resources and generation of waste in Northern Karelia is occasioned by export needs, i.e. the products of ore extraction, wood processing and the food industry, for exports, abroad and to other parts of the country, from a greater part of the regional economy than elsewhere in Finland on average and are composed predominantly of the products of resource-based industries. The proportion of total production which is exported abroad is higher in Northern Karelia than anywhere in Southern Finland with the exception of the province of Kymi, and the third highest of anywhere in the development regions (Volk & Eskelinen 1982: 71). The imports and exports of a peripheral region form a part of the global pattern in the exchange of goods. The Helsinki conurbation, on the other hand, is of little significance as a purchaser or seller of intermediate products of industries in Northern Karelia (cf. Eskelinen & Sullström 1979), even though it occupies a critical position in decision-making and administration with respect to industrial production in the resource peripheries. Even so, it may be said that external impulses reaching the periphery, in the form of demand, decisions, etc., are paramount in the whole process of direction and control of the utilization of materials.

Resource utilization and environmental loading: regional comparisons

It is now necessary to put the significance of resource utilization and waste generation in this peripheral economy into perspective within the whole core-periphery framework by means of a set of regional comparisons. For this purpose the intensities with which resources and power are

utilized and waste generated within the production system may be expressed per inhabitant, to indicate the *functional intensity* of the system, or per unit surface area to yield the *areal intensity* (cf. Paterson 1978: 29). These two concepts may be used to examine the properties of the production system in this resource periphery in relation to the production systems of other areas.

Total water consumption in Northern Karelia in 1975 was approx. 1000 ltr./inh./day, with separate thermal power stations accounting for less than 1% of total water use. This consumption figure is low by comparison with data for the whole country, where 2250 litres per inhabitant per day were consumed on average in 1972 and 1978, exclusive of the condensation water required in thermal power stations (Environmental statistics 1974, 1980), about 68% of this being accounted for by the paper and pulp industry and the manufacturing of chemicals and metals in 1972. It is precisely these branches of industry that are badly underrepresented in Northern Karelia, and hence the low consumption of water. On the other hand, more water is used per inhabitant here than in many major cities of the world (Table 8), where the figures are then increased many times over by thermal power stations. The water consumption figures for Finland would increase to 2600 litres/inh./day in 1972 and 4100 litres/inh./day in 1978 if the water used in thermal power stations were taken into account.

More than 5/6 of the water taken into use in Northern Karelia in 1975 was for industrial purposes, and any increase in wood processing in the region would cause a marked rise in water consumption. It may also be that thermal power stations will form a major source of increased demand for water in the future.

Structural differences between production systems give rise to discrepancies in power utilization within a core-periphery system. Calculated in terms of oil equivalents, total power consumption in Northern Karelia in 1981 was 3.88 equ. tonnes/inh./yr., somewhat below the mean of 5.24 equ.t./inh./yr. for the whole country (SVT XLIII: 1; Pohjois-Karjalan seutukaavaliitto 1984a). On the other hand, total power consumption in the region increased by almost a third between 1976 and 1981, whereas the increase over the country as a whole was only 12%. The exceptionally steep increase in power consumption in this region was due in part to the general process of industrialization and in part to the greater production capacity employed in the

Table 8. Comparative material for resource use, energy consumption and waste generation (Aston et al. 1972; Douglas 1981; Kalma et al. 1972; Newcombe et al. 1978; Wolman 1965).

	Water supply		Energy use GJ/inh./yr.	Consumption of		Solid waste
	total ltr/inh./day	domestic ltr/inh./day		food kg/inh./yr.	wood kg/inh./yr.	
Northern Karelia (1975)	958	121	107	(1 550)	(1 160)	732
Hong Kong	452	136	32	445	175	416
Sydney	380	225	88	515		
Melbourne	317	196				
An American city	625		142	730		

Total water supplies in Hong Kong would increase to 1200 ltr/inh./day if cooling water in thermal power stations were included. Total food imports in Hong Kong are 606 kg/inh./yr. and the wood consumption figure represents wood imports. Agricultural resources include intermediate products, so that the figure of 1550 kg is not comparable with the consumption data for the other metropolises. Food production in Northern Karelia, including exports, amounted 3400 kg/inh./yr., and wood exports and supplies to industry in 1975 were 9200 kg/inh. (including imported wood). Total wood consumption in years of economic expansion can be as much as on third higher than that for 1975.

wood processing sector after the depression years of the mid-1970's. Thus a significant increase in power consumption took place in chiefly in the resource-processing sector of the economy and other manufacturing processes, even though the absence of any true heavy processing industries is one factor likely to reduce power consumption relative to other parts of Finland.

The importance of resource processing and similar industries as consumers of power emerges well from the figures for power consumption at the commune level, which are markedly higher in those communes possessing industries of this kind (Fig. 19).

Power intensity, i.e. power consumption relative to labour input (Fig. 19), may be measured in terms of electricity consumption in industry per industrial employee (SIC 2—4) (SVT XVIII A: 101), expressed in kwh/employee/yr. This power intensity is seen to be higher than average in those localities possessing wood processing mills or where mining is carried out, especially in Eastern and Northern Finland. Local above-average figures in Southern and South-Western Finland are also brought about by chemicals factories (Fig. 19). It is interesting that only about 55% of the localities depicted in Fig. 19 have the status of towns, the rest being rural communes. Power intensity in the major cities, e.g. Helsinki, Tampere and Turku, lies below the mean for the whole country.

Industry in Northern Karelia reached a power intensity of 33.3 Mwh (per employee per year) in 1980, somewhat below the national average of

40.4 Mwh. Consumption was 29 Mwh in the urban communes and 45 Mwh in the rural areas. The power intensity figure for Uusimaa, on the other hand, was well below the average for the whole country, at only 18 Mwh per industrial employee per year, due to the low power intensity of the industries located in Helsinki and the other towns in the province, as low as 10 Mwh in towns on average, and no more than 8 Mwh in Helsinki itself in 1980.

The extent of power consumption can be affected markedly by the contributions of individual factories, so that the power intensity figure for the rural areas of Uusimaa in 1980 drops abruptly from 57 Mwh to 36 Mwh as soon as the rural commune of Porvoo, the site of a major oil refinery, is excluded. There are also many other factories in the southern part of Finland that use large quantities of power to process imported natural resources, a feature not characteristic of resource use in the peripheral areas.

The greatest regional differences are to be found at the level of resource use in specific industries. The total cut of timber from the forests of Northern Karelia in 1980 was 29.8 m³/inh./yr., for example, as compared with a mean of 12.9 m³ for the country as a whole and a figure of no more than 2.3 m³ for Uusimaa, on account of the high population density of the region (Huttunen 1982; STV 1981; cf. also Table 8). Correspondingly, agricultural production per head of population is substantially lower in Uusimaa than in Northern Karelia, by a factor of 2.5 for meat production in 1980, 8.5 for milk produc-

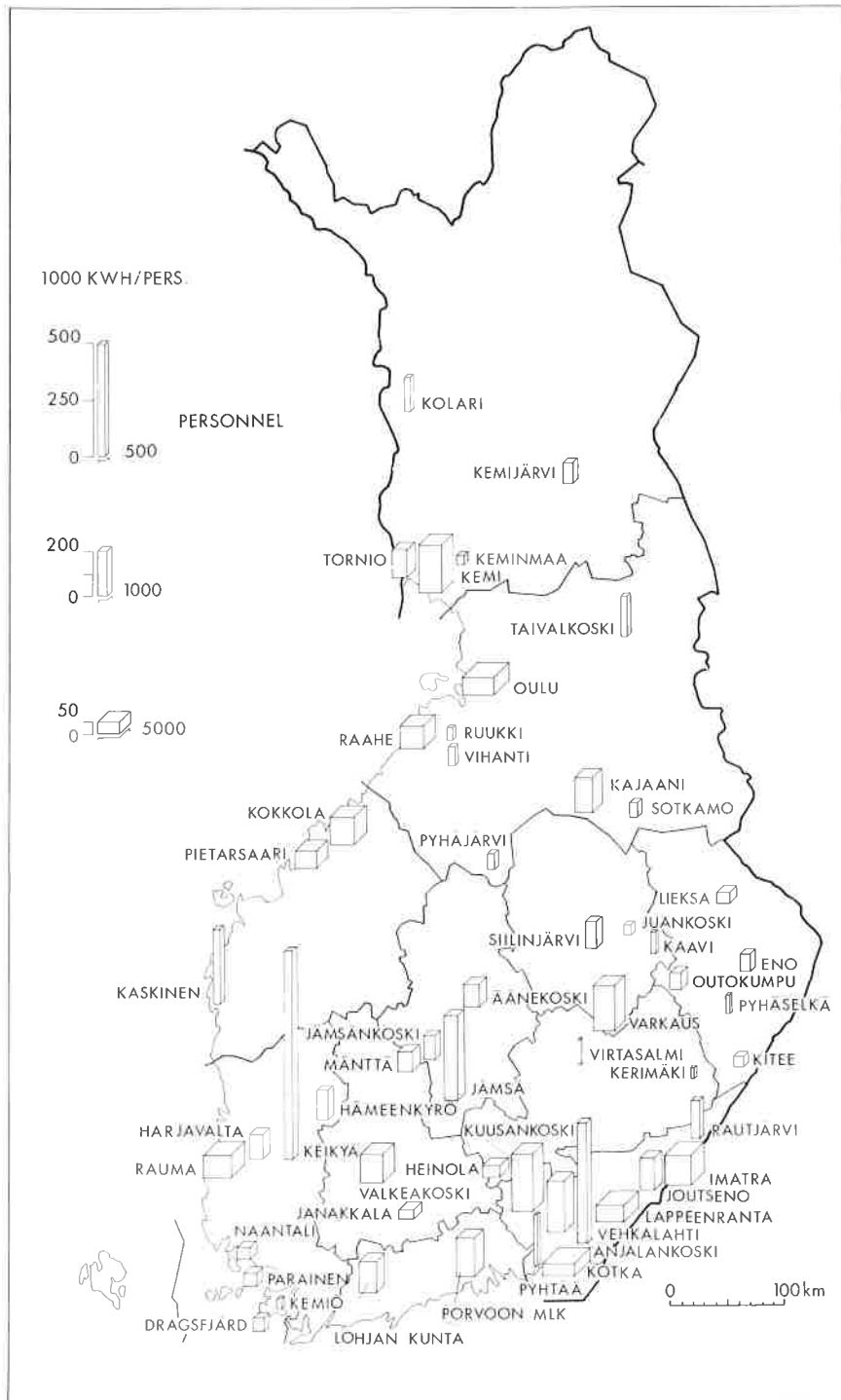

Fig. 19. Use of electricity in industry in 1980. Only those localities are marked on the map which had a power intensity higher than national average.

tion and 1.5 for cereals (SVT III: 79; STV 1981). On the other hand, pork production in Uusimaa was 13 kg/inh./yr., practically equalling the level of 15 kg/inh./yr. reached in Northern Karelia, while the latter province is not really a wheat-producing area at all and its harvest of this crop in 1980, 10 kg/inh./yr., was only a fraction of that recorded in Uusimaa, 87 kg/inh./yr. (SVT III: 79; STV 1981). The total extent of production in forestry and agriculture in Northern Karelia, expressed in terms of weight, nevertheless amounted to only about a third of that achieved in mineral ores and gravel, the figure for which was 33 tonnes/inh./yr. in 1975, 44% of which was exported from the region (i.e. the ores).

Waste water is characteristically generated in proportion to water consumption, just as effluents released into the air are proportional to the use of fuels. Thus the lower than average figures for the utilization of both water and power in Northern Karelia already suggest that less of the related waste is generated than in other parts of the country. The production of non-recyclable waste in the region in 1975 was in fact approx. 550 kg/inh./yr., well below the mean estimated accumulation of waste on rubbish dumps throughout the country of 802 kg/inh./yr. in 1974 (Environmental statistics 1980). On the other hand, the proportion of sludge in the waste was very much higher nationally than in Northern Karelia.

It may thus be seen that environmental loading, power consumption and in some cases also the utilization of natural resources remain below the levels for the whole country and its industrialized areas in the case of Northern Karelia, implying a low functional intensity which is undoubtedly an outcome of the relatively short processing chains typical of such a resource periphery. In terms of areal intensity, the figure obtained for Northern Karelia is only a fraction of that for the more industrially developed parts of the country, since the region has a very much lower population density. Among the provinces of Finland, Uusimaa, that with the highest population density, achieves a figure 11.5 times that for Northern Karelia, and the other industrialized provinces of Southern Finland, those of Turku and Pori, Kymi and Häme, likewise exceed Northern Karelia by a wide margin in this respect.

Spatial variations in areal intensity are least marked in the case of forestry, where the distribution of the values is proportional to the timber yield of the forests. The total cut in North-

ern Karelia in 1980 was 296 m³/sq. km compared with 268 m³/sq. km in Uusimaa and an average of 196 m³/sq. km for the country as a whole. Quite pronounced regional discrepancies occurred in agriculture, however, the farming land of Uusimaa being exploited very much more intensively than that of Northern Karelia. Thus the combined yield of cereals (wheat, rye, barley and oats) in 1980 was 42.4 tonnes/sq. km in Uusimaa but only 5.8 tonnes/sq. km in Northern Karelia. Similarly meat production in Northern Karelia, at 0.5 tonnes/sq. km was only about a quarter of that in Uusimaa, due primarily to a lower level of pork production, and the intensity of milk production was also substantially lower, 12.7 kltr/sq. km as compared with 17.0 kltr/sq. km in Uusimaa (SVT III: 79).

Areal intensity in industry and power generation is more local in character, being dependent on the siting of the factories and power stations and the inputs required for these. This may be seen in the case of power intensity in Fig. 19, for example. These sharp differences are evened out somewhat when areal intensity is examined at the provincial level, however, where this measure serves well to indicate the degree of exploitation of the natural environment in the region in question.

An attempt will be made in the following to give a general picture of variations in areal intensity in Finland at the provincial level when industry and the service sector are included. Here value added will be used to denote the extent of production in each sector, since it may be taken as a rough indicator of the utilization of materials and power and of the generation of waste in any given branch of the economy (Table 9). The consumption of electric power by industry (SIC 2—4) per unit area is then used as an additional measure of the areal intensity of industrial activity (Table 9).

The intensity of exploitation of the environment (resource use and waste generation) can be described fairly comprehensively in terms of the intensities of primary production, processing industries and the use of electric power. The value added in primary production per unit area (areal intensity) is lower in Northern Karelia than in Southern Finland, and the areal intensity figures for both the consumption of electric power and energy production are also low. Thus the specialization in exploiting local resources taking place in this resource periphery may be said to be operating at an areally extensive level.

Concentration on the primary sector and the

Table 9. Value added 1980 in basic values (1000 FIM) per sq. km (Regional accounting 1980; STV 1981), and use of electricity Mwh per sq. km (SVT XVIII A: 101, STV 1981).

Value added Region	1000 FIM per sq. km				Use of electricity in SIC 2—4	
	Primary 1, 2	Manufact. 3	Power 4	Services 5-9,0	!	Mwh per sq. km
Uusimaa	102.07	1 140.33	114.05	3 632.40	!	246
Turku and Pori	103.29	363.97	43.75	563.48	!	157
Åland	54.35	49.31	3.73	634.18	!	9
Häme	96.16	527.22	36.35	693.14	!	133
Kymi	96.35	397.33	49.24	562.78	!	499
Mikkeli	82.25	82.25	5.00	195.14	!	23
Northern Karelia	73.07	49.78	5.04	154.25	!	25
Kuopio	83.62	95.70	16.18	256.86	!	88
Central Finland	67.82	132.28	13.57	251.75	!	93
Vaasa	95.62	160.23	10.21	273.85	!	63
Oulu	36.60	48.78	6.69	126.50	!	41
Lapland	10.53	14.00	3.52	39.09	!	18

processing of its products is to a significant extent a feature of industrial regions surrounding core areas, and not exclusively of resource peripheries, but in the case of industrial areas the use made of local resources is of an areally intensive kind. This also implies a considerable power input and high waste loading, and the prominent role played by the processing of primary products causes the connections with the resource base to be more complex in nature than in the periphery and frequently to extent out into the periphery. The exploitation of natural resources and processing of the resulting products is of less significance for total production in industrial areas than it is in peripheral areas, due to the dominant position occupied by other, usually light industries, but the material flows involved are nevertheless considerable and represent the outcome of an areally highly intensive exploitation of the environment in various sectors of industrial activity.

Material flows and economic transition in the periphery

The core-periphery dependence relations emerging here proved to be very much of the kind set out in the model in Chapter "Core-periphery relations..." Control functions stand out as being associated with a clearly identifiable core area at the national level, while the primary ends of the production chains are intersectorially over-represented in the resource periphery, with many

of the manufacturing functions which require a high degree of working up of their raw materials tending to be situated in industrial areas, close to their markets. In the case of Finland, the more developed region of Southern Finland represents not only a more intensive utilization of industry and services than does the resource periphery, but also more intensive primary production (higher value added in primary production per unit surface area). Thus the resource periphery cannot be regarded as a spatial manifestation of primary vs. secondary sectoral specialization, but rather as the consequence of a structural organization in which the periphery has remained at the level of producing, and in part also processing, primary sector products in a fairly extensive manner.

As occurs in many cases, the materials and power used for production purposes in the resource periphery tend to increase in amount in spite of the fact that the contribution of resource-based functions to employment and the economy in general is declining. The food and wood processing industries in Northern Karelia continued to grow in absolute terms even during the economic transition of 1960—80, in the course of which considerable rationalization took place in the use of labour in primary production, but the region has now reached the point at which mining is on the decline and the most urgent infrastructure investments requiring the use of non-renewable natural resources, e.g. construction of roads and canals, have been completed for the present.

Rationalization in the resource-based sectors will naturally release labour for use in the service sector and the newer industries, the latter introducing a separate stratum into the economy of the resource peripheries which will not have any pronounced impact on either the utilization of natural resources and power supplies or on the amounts of waste generated.

These new industries can be expected to have spin-off effects which will more often extend outside the region than in earlier times, largely due to the demand for intermediate products, whereas they will have very little impact on primary production in the resource periphery itself. Their waste loading, both direct and indirect, will be substantially less than in resource-based manufacturing as practised in the periphery, and they require a lower input of power and untreated water. Thus the environmental hazards attached to industrial production can be expected to decrease, at least in relative terms, as the proportion of new industries grows, and will tend to be concentrated in those areas where the raw materials for such industries are obtained and processed into intermediate products. The future extent of resource exploitation and waste loading in the regional economy and the power consumption of that economy will thus be crucially dependent on what stages in the production chains for such industries are located in that economy and how the spin-off effects are directed within the spatial economic system.

The proportion of total production in a resource periphery accounted for by resource-based sectors exercises a substantial influence upon the flows of natural resources, power and waste in that periphery. Any increase in production in these sectors will imply an increase in waste generation, and also in power consumption where processing functions are concerned, which is likely to be many times greater in amount than in other sectors of the economy. Such increases can be smoothed over by means of changes in production techniques, but can scarcely be reduced to the same level as in the new industries.

Exploitation of the majority of natural resources takes place at an areally more extensive level in the resource periphery than in more developed regions, and thus the use of these resources could be increased many times over in terms of value added, and in many cases also in absolute terms, before the same areal intensity in the use of power and materials and the generation of waste were achieved as prevails in the

industrialized region of Finland. Increased volumes and intensity of resource use and processing would in turn step up the material flows (Fig. 6), the significance and environmental effects of which would naturally vary greatly according to the resources exploited and the manner of their exploitation.

Revising the economic structure of a resource periphery

Seeking alternatives

An attempt will be made in this chapter to evaluate the potential of the economy of Northern Karelia in relation to the use of natural, human and capital resources. This analysis will be focused on the restructuring which has taken place to date and the manner in which the transition in this peripheral economy can be expected to continue, i.e. the manner in which the major relations operating within it may develop (section "Core-periphery relations ..."). The development of the regional economy will be analysed against various types of goals, conditions and limitations. The goals consisting of the attaining of profitability and full utilization of natural resources, while the conditions and limitations concern questions of demand, natural resources, labour, capital and institutional factors (including regional policy).

Various approaches may be adopted to the development and potential of a regional economy (see Nijkamp 1984; Snickars et al. 1982). Principal attention will be paid here to the evaluation of these aspects at the neo-industrialization phase and to alternative paths of development for economic transition. Thus it is necessary to decide on an approach which will be applicable to the evaluation of both alternative forms for the present structure of the economy and alternative directions in which it may advance in the future. The former type of evaluation may be referred to as counterfactualization (cf. Elster 1978: 175—218) and the latter as a scenario approach outlining the framework for development.

It is common practice when evaluating prospects for economic development to analyse the current situation first and then to estimate future development by one or more of the following methods:

- 1) extrapolation of future trends,
- 2) future planning,
- 3) evaluation of future opportunities and a search for alternatives.

It is the third approach which is preferred here (for methodology, see Segerståhl 1981, Snickars et al. 1982), since this allows developmental states of several different kinds to be outlined and compared. The development of a peripheral economy consists to a great extent of structural alteration and adaptation to a changing functional environment. It is the outcome of changes in demand and productivity and of adaptation of the infrastructure to the conditions imposed by such changes (see also Nijkamp 1984). Although future lines of development are bound by the structural features of the peripheral economy and by external factors such as demand and commercial policy, development of such an economy is to a great extent the outcome of a set of private and public decisions to react to demand and technological progress. The environment within which industry functions is shaped by decisions made in the spheres of regional, financial and industrial policy, and development in peripheral areas has been influenced in the past, and will continue to be influenced, not only by market forces but also by controlling governmental decisions. Thus when considering the alternatives with regard to both the counterfactual situation and the advancement of the transition (i.e. visions of the future), regional development can be treated as a problem of choice delimited by social and environmental factors. Examination of the alternatives which exist makes it possible to evaluate the courses along which regional development could be, or could have been, directed. This enables a dynamic aspect to be added to the core-periphery model (section "Core-periphery relations . . ."; Fig. 6).

Modelling of development and structural changes in a regional economy is a problematical task, since a 'small' regional economy is open to, and dependent on, many external factors. Its smallness also means that random factors such as individual production decisions gain considerable importance, while regional policy measures as means of controlling the location of industry can, if so desired, have a major influence on regional development, e.g. in determining the branches of industry represented. The seeking of alternatives is justified all the more in view of the strong influence of such exogenous and random factors.

Models available for this purpose are customarily divided into single-region and multi-region types. In the present case the alternatives for the transition phase in the economy of a peripheral area are being evaluated from the point of view of the development of that area, with the development of the whole national economy serving as the boundary condition. This situation may be described as a bottom-up stage in multi-regional evaluation and planning, the design of which proceeds at the single-region level. The results obtained for the individual regions are then combined (after any balancing and adaptation needed) to form a model to represent the national economy and a solution for its organization (Glickman 1982: 88—90). Bottom-up modelling is especially suitable for emphasizing evaluation based on boundary conditions and goals laid down for sub-areas, whereas use of a top-down approach would quite probably leave examination of the regional alternatives in a subordinate position to the general development of the economy, since this operates by dividing development on a national scale among the regions, setting this up as its final result. Bottom-up modelling, on the other hand, expresses the development of the national economy in terms of an aggregation of contributory regional economies. A balanced overall view of the economy would, in fact, call for a combination of the two approaches. The present work nevertheless applies the bottom-up approach to the evaluation of the economic structure of a single region, from which viewpoint accounting for the national economy and optimization of the division of labour between the regions become secondary considerations and can be ignored here. The essential thing from the point of view of a single region is the industrial production in that region, its profitability and its effects on employment, the environment, etc.

Models describing growth and development in a regional economy can themselves be grouped into at least the following types: export base models, neoclassical models, cumulative causation models, econometric models, input-output models and multisectoral development planning models (Richardson 1977). Such models are able to draw attention to growth in the regional economy and the generation of various multiplier effects, for instance. Aspects which have been highlighted in discussions on regional policy in recent years are the structure of production and the changes taking place in technology (see Ewers & Wettman 1980), and scenario examinations and

searches for alternatives have achieved prominence as planning instruments (Hynynen et al. 1979).

We shall analyse the development process in a regional economy here in terms of the economic results it achieves, in terms of profitability, capital requirements, wage incomes, etc.. A multisectoral model is proposed for evaluating economic development in Northern Karelia which permits the setting of initial conditions which deviate from the current structure of the economy better than do many traditional models, particularly deterministic ones. This model, a linear evaluation model and associated simulation model, takes account of the possibilities for changes in the structure of the economy, although advances in technology are limited to the use of the potential existing at present in the production technology employed within the national economy.

The alternatives arising here, generated by the model, are intended for the evaluation of paths of development for the resource periphery concerned and the revealing of the spin-off effects of development. Examinations are made of profitability, capital and infrastructure requirements, environmental loading, employment and susceptibility to economic growth in the alternative developmental strategies. With the constant change in the conditions governing economic activity, such research naturally cannot produce lasting, unambiguous solutions for Northern Karelia, but it can attempt to create reasoned visions of the future in terms of the opportunities offered by the channelling of regional development and its spin-off effects in a resource periphery.

The evaluation method

An outline

The most sophisticated of the numerous models which have been constructed for describing regional development are the pure theoretical models (e.g. Fujita 1978), while in addition to typical econometric models (Ghali & Renaud 1975), multisectoral models are highly familiar and have gained a powerful emphasis in planning variables in the physical environment are being taken into account to an increasing degree (see James et al. 1978; Coupe 1976). More extensive schemes have also been conceived in which economic activity at the regional level is included as one part of the whole national or global econo-

my (e.g. Isard & Smith 1983). In the case of Northern Karelia, emphasis is placed on the use of resources and the problems of sectoral growth in the economy, the aim being to construct a model that can be used to evaluate different types of developmental strategy and their consequences, especially in an industrial context.

The theoretical starting points for the evaluation aimed at creating the necessary alternatives are set out in block diagram form in Fig. 20, in which the blocks depict different areas of the problem and the arrows denote effects and their directions. The trends and expectations in the global and national economy at the top of the diagram set the limits for feasible solutions. The goals of industrial and regional policy are then brought to bear upon the development of the regional economy via a set of stimuli and constraints. The goals of economic policy are laid down in such a way as to promote competitiveness at the national level, while the purpose of regional policy is to promote balanced economic growth. The current structure of the regional economy also places certain constraints upon development (e.g. skills, employment, levels of technology, industrial quality, etc.), all of which exert some influence on the search for new solutions and on their evaluation.

Certain restrictions on the use of local natural resources also exist within a regional economy (e.g. felling schedules in forestry, harvest yields in agriculture), and these can only be altered over relatively long periods of time if it is thought desirable to increase the utilization of such resources, for if exploitation is to be increased on a long-term basis a permanent improvement has to be achieved in the supply of such resources. Degeneration of the resource base and industrial pollution constitute environmental limitations upon industrial changes. Also, for many national and regional reasons there will be some necessary production targets and necessary supply targets determined by self-sufficiency requirements, relations between industries or spatial specialization in production, etc. Such minimum production goals exist in agriculture, for instance, and in industries regarded as being of strategic importance.

If all the factors affecting production are known, an optimal structure and optimal level can be determined for a regional economy. Optimization, however, requires first the definition of which factor or factors should be selected for optimization. Since the factors affecting regional development cannot be predicted with accura-

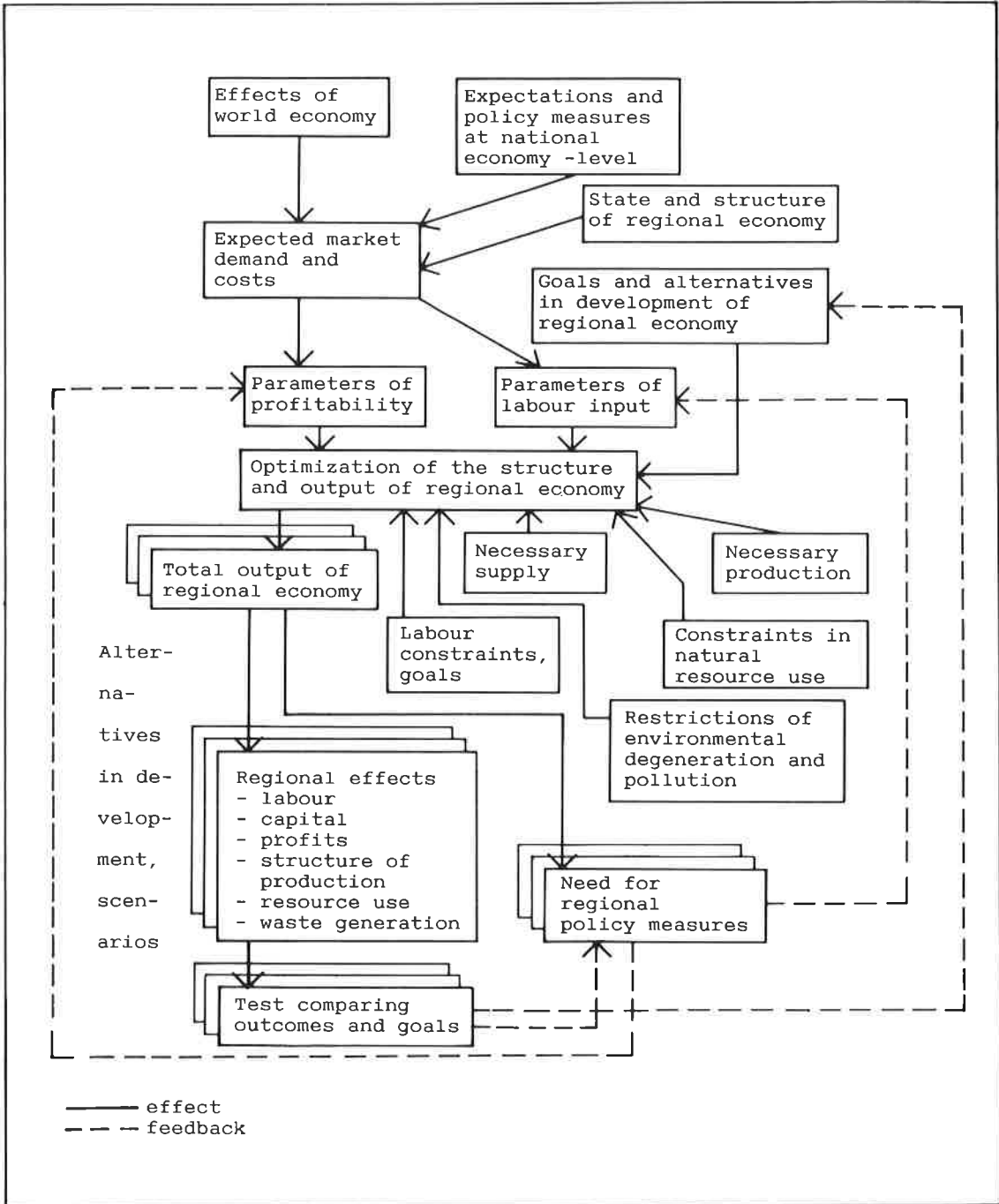

Fig. 20. Outline of an approach for evaluating a predominantly resource-based regional economy.

cy, however, and since the goals set for regional development may be partly conflicting, it is preferable to create a system of alternative paths of various kinds.

In economic theory an economy is constructed according to the profitability criterion, and economic changes are similarly guided by this criterion. Profit is therefore paramount, and suc-

cess in economic development is precisely an outcome of the choices which have generated the profit and thereby ensured the continuity of economic activity.

Employment factors are often emphasized in the planning of a regional economy, sometimes serving as goals and sometimes as limitations (Fig. 20). One can operate with a fixed level of employment in mind, a level which ought to be achieved in order to ensure a rough equilibrium between supply and demand on the labour market. Profitability and employment need not be at variance one with the other, provided labour is channelled towards those sectors which are producing a profit as judged on commercial and economic grounds.

The structure and level of production will exert regional effects on employment, resource use and the environment. Employment, wages and salaries are important considerations in regional development alongside profitability. Calculations of resource use are particularly necessary if demand threatens to exceed the local supply of the resource in question, and in this sense requirements in terms of electricity, head and water supplies in the various alternatives are evaluated via the input requirement for each. Changes in the capital required enable one to estimate the regional policy subsidies needed to finance investments. Calculated in this way, the consequences or spin-off effects of the various alternatives can be compared with the goals and an evaluation can be made of the potential for development.

This theoretical framework serves as a basis for the multisectoral evaluation model developed here and for its applications. The framework is operationalized in terms of its main principles. The fundamental starting point is an evaluation of the directions available for developing the peripheral economy and the spin-off effects of these, so that the basic choice regarding the structures of the majority of the models in terms of principle and level of accuracy are determined with this goal in mind.

The approach adopted here is evaluatory and comparative. The system of production in the resource periphery is assumed to function in an environment in which demand and the conditions for production can fluctuate markedly, thus regulating production. One crucial object of examination here is the end-point of the development, the economic state produced by the system of production, indicators of which are profitability, resource use, structure of the labour force, capital requirements, etc. In the counter-

factual situation this end-point is optional, a hypothetical present moment, while in the transition case we obtain a set of alternative future situations. The approach is also influenced by the scenario tradition to be studied (Hynynen et al. 1979), but since we are concerned here with testing a theoretical model (section "Core-periphery relations . . ."), our discussion will be limited primarily to an examination of those problems and variables which are of most crucial importance.

Structure of the model

The evaluation model is composed of a simulation and a linear programming (LP) model which together describe the structure of industry (SIC 2—4) in the region. The LP model is employed for optimization purposes and the simulation model for analysis of the spin-off effects of the results of the various developmental alternatives.

Economic growth and development in a periphery are based on the production opportunities which this periphery is able to offer and to a considerable extent on external demand. In an open peripheral economy, changes in external demand crucially affect employment, incomes, etc., since industry can be very much more flexible in terms of volumes of production and range of products than is the primary sector. Similarly, one cannot say that industry (manufacturing and alike) is non-basic in the same way as many services are. The evaluation model thus treats industry (SIC 2—4) as a sector with variable volumes of production.

The empirical material for this evaluation phase of the research is taken from the year 1978 and the period 1974—79, so that past, present or future situations are evaluated by reference to this period. The analysis is also restricted to the manufacturing and allied industries (SIC 2—4), while agriculture, forestry, the service sector and consumption are assumed to remain at their 1978 levels or undergo only minor changes.

Agriculture and forestry are included in the evaluation model as sectors providing a supply of natural resources, the extents of which (assuming maximal exploitation) form the limiting factors in the calculations. The volume of agricultural production is usually assumed to remain constant over the country as a whole (see Talouellinen . . . 1981: 94), an assumption which will also suffice to establish the level of agricultural production in Northern Karelia for the purposes

of the present model. Production in forestry, on the other hand, is governed by felling schedules, which in the present region cannot be increased to any appreciable degree beyond current levels. Thus it is assumed that no substantial changes will take place in volumes of production in either of these branches of the primary sector. This also means that the requirements for electricity and water in agriculture and forestry can be taken as constant, and may be treated as such when used as power and water supply components. Growth (or decline) in the service sector is largely bound up with changes in incomes and measures undertaken by the public authorities. The service sector is also taken into account as a demand component in relation to power and water supplies, where it is assumed to be constant between the alternatives studied.

The optimization part of the evaluation model, the LP model, contains 48 industries in manufacture and mining, 21 of which now exist in the region, the rest being found nationally (see Appendix 4); the simulation model also includes branches *s* and *w*, i.e. power supplies (electricity, gas and heat) and water. Output can be achieved by two types of technology, technology native to Northern Karelia (industries 1–21) and national technology (industries 22–48). The objective function consists of parameters describing the net rate of returns from the different industries, where the variables are their total outputs. Thus the parameters are:

$$(16) \quad a(i) = (j(i) - w(i) - d(i)) / x(i)$$

in which $j(i)$ = value added in industry *i*,
 $w(i)$ = wages and salaries in industry *i*,
 $d(i)$ = depreciation in industry *i*, and
 $x(i)$ = total output of industry *i*.

The values for $d(i)$ are calculated by recording all machinery and vehicles at 15% of their fixed capital value and all buildings at 5%.

The figures used in the model are arithmetical means of the net rates of returns over the six years 1974–79, based on published and unpublished industrial statistics (SVT XVIII A: 95–100). Gross rates of returns are also calculated in order to assess the influence of the depreciation allowances on the results, since the gross rates of return shows the economic outcome in relation to the total output without any allowances for depreciation: $B = (j(i) - w(i)) / x(i)$. The net rate parameters are presented on the A axis of Fig. 21 and the gross rates for comparison purposes on the B axis. Their correlation coefficient when

calculated for the whole material is .70 (SIC 2–4, 1974–79, $n = 303$). If we assume that all branches are equally profitable (taking account of capital expenditure), profitability measured from the gross rates of returns should be the greater the more capital-intensive the industry concerned is. Most of the capital-intensive branches of industry in Northern Karelia nevertheless have both parameters relative low, and thus the effect of the depreciation allowance on the net rate of returns is by no means excessively great, especially when we bear in mind that capital expenditure is inevitable and renewal of capital essential from time to time.

The stability and generalizability of the results in relation to different phases in economic fluctuation are evaluated here by means of models set up for two contrasting periods, the results being compared with the profitability-based alternative obtained using the LP model. The effects of economic expansion on the calculations from the LP model (profitability-based alternative) are examined by using as the parameters of the objective function the net rate of return parameters for the expansion years 1974, 1978 and 1979, and the effects of recession conditions by using those for the recession years 1975–77. Optimization experiments indicate that the results are similar in kind under both sets of conditions. We will return to these results at a later stage.

These parameters give us the objective function:

$$(17) \quad \max z = a(1)x(1) + a(2)x(2) + \dots + a(48)x(48)$$

The intention at first was to use fixed capital sums as the variables and net gains for fixed capital as the parameters, but because of the unexpectedly large variation in the net gain coefficients (mean .264, $s = .429$, $n = 303$) it was decided to use the net rate of returns instead (mean .131, $s = .179$, $n = 303$). These two parameters are in any case quite closely correlated when calculated for the whole of the economy (see also Airaksinen 1978: 34), and thus the latter is satisfactory to describe the profitability of industries. The variation in net gain coefficients was especially large where the industries of Northern Karelia were concerned, reflecting the fact that these include many small or new factories which have not yet become properly established.

The labour force is taken here to consist of wage-earners, salaried employees and owners.

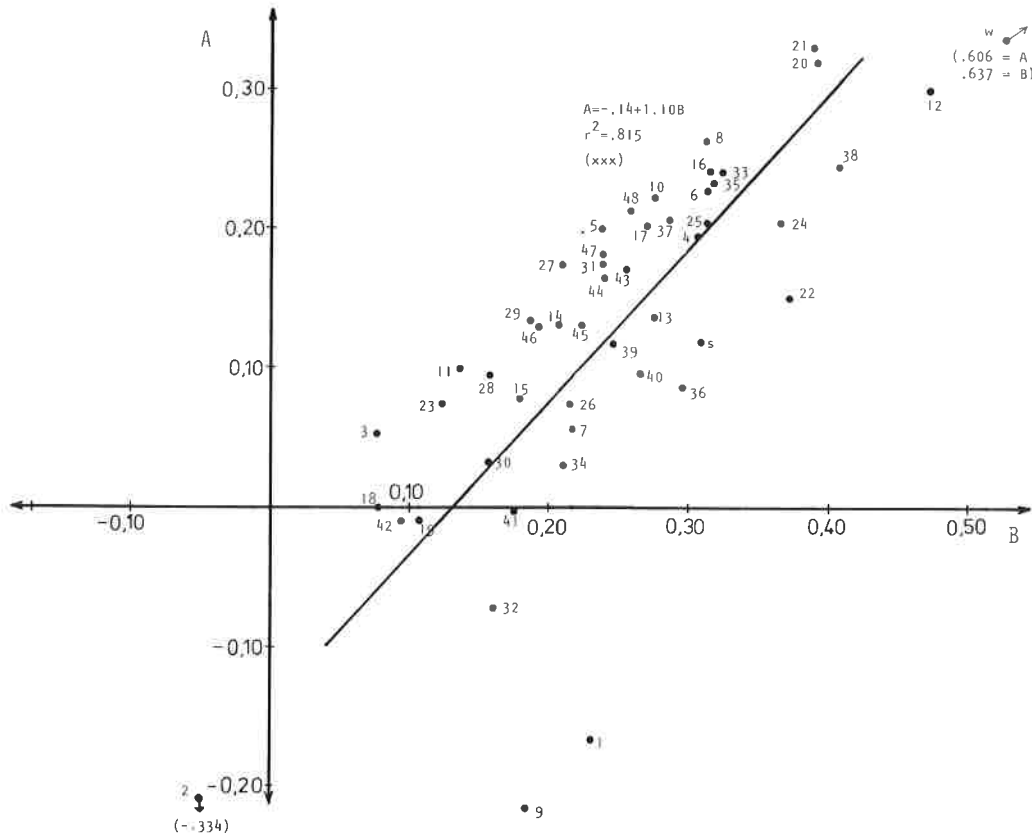

Fig. 21. Correlation between gross and net rate of returns on gross value. Numbers refer to the branches of industry listed Appendix 4.

The following constraint is established for the labour force

$$(18) \quad t(1)x(1) + t(2)x(2) + \dots + t(48)x(48) \leq b$$

Capital is equivalent to fixed capital (SVT XVIII A: 99), the constraint being:

$$(19) \quad c(1)x(1) + c(2)x(2) + \dots + c(48)x(48) \leq d$$

The maximum output constraint is set so that the maximum output of an industry cannot exceed the respective output at the national level, on the assumption that either the domestic market or restrictions contained in the national economy will place some constraints upon production.

Such limitations as the use of natural resources, minimum volumes of output in given industries, limits upon use of water, pollution and power supplies exist within the regional econo-

my, but since these did not prove particularly significant for the results obtained with the LP model in preliminary analyses, they were not taken into account in the final model.

The evaluation model also includes a model for simulating the effects of the optimization results. This contains the same industries as the LP model, together with the power and water supply sectors. Power requirements in terms of purchases by the respective industries are:

$$(20) \quad x(s) = e(a) + e(t) + e(w)x(w) + e(s)x(s)$$

in which $x(s)$ = output of the power sector, $e(a)$ is the autonomous power requirement for primary production, the service sector and household consumption, $e(t)$ the total power requirement for industry as a result of optimization, $e(w) \times (w)$ the power requirement in the water supplies sector, and $e(s) \times (s)$ the power requirement in the power industry itself.

The water requirement is obtained analogously from the equation

$$(21) \quad x(w) = v(a) + v(t) + v(s)x(s)$$

in which $v(a)$ is the autonomous water requirement for agriculture, forestry, the service sector (SIC 1, 5—9) and household consumption, $v(t)$ the total water requirement for industry as a result of optimization, and $v(s)x(s)$ the water requirement in the power industry. Water consumption in the water supplies sector is nil. Thus the output of the power sector is expressed as

$$(22) \quad x(s) = \frac{e(a) + e(t) + e(w)v(a) + e(w)v(t)}{1 - e(w)v(s) - e(s)}$$

Once this total output figure has been obtained, the total output of the power sector $x(s)$ is inserted into equation 21, enabling the total output in the water supply sector $x(w)$ to be solved.

In order to obtain further information on the spin-off effects of the various alternatives, the simulation model contains 8 groups of equations for the individual branches of industry:

- | | |
|------------------------------------|-------------------------|
| (23) net returns: | $z(i) = a(i)x(i)$ |
| (24) labour force: | $q(i) = t(i)x(i)$ |
| (25) capital requirements: | $p(i) = c(i)x(i)$ |
| (26) number of establishments: | $u(i) = n(i)x(i)$ |
| (27) number of wage-earners: | $m(i) = \hat{a}(i)x(i)$ |
| (28) number of salaried employees: | $y(i) = l(i)x(i)$ |
| (29) wages: | $j(i) = f(i)x(i)$ |
| (30) salaries: | $r(i) = g(i)x(i)$ |

Each group contains 48 branches of industry employed in the optimization and simulation experiments, together with 2 allied functions, power and water supplies. The coefficients $a(i)$, $t(i)$ and $c(i)$ are expressed in the former equations as well as the variable $x(i)$. The parameters in the equations 24—30 are estimated from data applying to 1978 (SVT XVIII A: 99), in addition to which the power requirement $e(t)$ and water requirement $v(t)$ are calculated by using the power consumption coefficients $e(i)$ and the water consumption coefficients $v(i)$. $e(t)$ and $v(t)$ are required to solve equations 21 and 22. The values for the coefficients $a(i)$, $t(i)$, $c(i)$, $e(i)$, and $v(i)$ are presented in Appendix 4.

The evaluation model, i.e. the linear programming model together with the simulation model, is static and linear in character, properties which should be borne in mind when interpreting the

results. In practice the parameters are especially subject to change due to technological advances, an aspect which is not usually taken into account in regional growth models in spite of the fact that a large proportion of the economic growth achieved is attributable to this factor (Malecki 1983). Such considerations are nevertheless found as a theoretical problem in the majority of growth theories. In the counterfactual approach technological progress is incorporated in the structural alternative for the economy, i.e. we assume that the technological solutions in terms of new production processes will be in accordance with the prevailing, known technology but that they will be located in the spatial economic system in quite a different way from before. When we set out to examine technological progress in a periphery which is heavily dependent on the whole national economy and even on the global economy, the assumption concerning the use of technology made in the counterfactual situation does not raise any insurmountable problems. The limitations imposed by the static nature of the model itself, however, will have to be taken into account when evaluating the alternatives. Another factor which may greatly influence future values for the parameters in the model is the increasing productivity of human labour. The role of technological progress in the evaluation of future lines of development will be taken up further in the discussion of the results.

Application of the evaluation model will commence with an examination of its parameters and a comparison of the distinctive features of economic activity in Northern Karelia with those of the economy of Finland as a whole. The model will then be used to evaluate the present structure of the economy in this resource periphery, after which an examination will be made of the profitability of the economy given development alternatives of different types. This will enable us to suggest the directions in which the economic transition should be channelled.

Characteristics of the economy of Northern Karelia

The period selected for the present evaluation of the economy of Northern Karelia marks the final stage in the transition, from 1974 to 1979, a transition which as a whole meant a doubling of industrial employment in the region between the years 1960 and 1980 (Table 10), including an increase of about 4000 jobs in the new industries.

Table 10. Labour force in Northern Karelia 1960—1995 (1000 persons) (Lääneittäinen . . . 1982).

Year	Agriculture and forestry	Manufac- turing	Services	Total demand	Supply of labour	Unemp- loyment rate
1960	54	6	29	89		
1870	31	8	36	75		
1980	17	14	40	71	77	7.6
1985	15	15—16	41—42	71—73	78—79	9.0—7.6
1990	14—13	16—17	42—45	72—75	78—80	7.7—6.3
1995	13—12	16—18	43—46	72—76	78—80	7.7—5.0

Thus the model comprises both 'old', traditional branches of industry and new branches of the kind which attained significance only during the 1970's.

The state of the region's economy is described by the simulation model, the variables in which are assigned the values indicated in Table 11. (Branch 352, also quoted in the results, is not included in the actual simulation since its data apply only to the year 1978.) The results show that

the area has five industries for which the profit value is negative, i.e. they produced a mean loss over the six-year period, the worst situation being that in pulp production, where the only profitable year was 1974.

The fact that the model gives a smaller sum of net returns suggests that 1978 was a better than average year in relation to the period as a whole. The correlation between the actual net return and that given by the model is .89. The net rate of

Table 11. The industries in Northern Karelia, main indicators.

Industries	Estab- lishm.	Personnel total	Gross value mill. FIM x(i)	Fixed capital mill. FIM p(i)	Net returns actual 1000 FIM	Net returns model z(i)
	u(i)	q(i)				
230 Metal ore	2	1 247	164	510	2 495	— 27 906
290 Other mining	1	26	13	31	— 4 342	— 4 342
311-2 Food pr.	48	1 578	511	217	23 737	25 567
321 Textiles	3	245	22	23	4 368	4 364
322 Wearing app.	13	960	74	23	13 221	15 242
323 Leather pr.	2	20	2	.5	943	444
331 Wood pr.	30	2 068	443	746	17 551	25 272
332 Furnitures	8	193	24	14	5 404	6 483
341 Pulp, pap.	4	1 238	215	792	— 83 213	— 46 686
342 Print., publ.	16	602	72	41	17 050	16 203
351 Indust. ch.	1	28	20	16	3 839	2 021
352 Other chemicals	1	14	1	.2	369	369
355 Rubber pr.	1	301	54	74	21 658	16 714
356 Plastic pr.	3	138	12	21	1 675	1 700
369 Mineral pr.	15	402	51	31	6 363	7 044
371 Iron and steel	1	51	4	5	423	348
381 Metal products	12	889	94	61	21 452	22 886
382 Machinery pr.	15	773	147	84	40 873	30 212
383 Electrical eq.	2	49	5	3	1 331	— 25
384 Transport eq.	4	106	14	14	1 030	— 163
385 Instruments	1	4	.4	.3	121	130
390 Other manuf.	2	146	35	16	13 984	11 621
410 Electr.	17	663	194	282	24 770	22 852
420 Water supply	3	33	7	2	4 946	4 483
Total SIC 2—4	204	11 774	2 180	3 007	140 049	138 703

Table 12. Correlations between the main parameters, industries SIC 2—3. The industries present in Northern Karelia (N-K) are nos. 1—21 in the list in Appendix 4 and those present in the national economy (Fin) are nos. 22—48.

		Labour t(i)	Fixed capital c(i)	Power demand e(i)	Water demand v(i)
Net rate of returns a(i)	N-K	.334	— .745	— .242	.220
	Fin	.521	— .417	— .703	— .359
Labour t(i)	N-K		— .222	— .184	— .118
	Fin		— .341	— .478	— .501
Fixed capital c(i)	N-K			.398	— .034
	Fin			.762	.092
Power e(i)	N-K				.147
	Fin				— .036
Risk levels	NK df = 21		Fin = 27		
5 %	.413		.367		
1 %	.526		.471		
.1 %	.640		.579		

returns in mining is higher than that for 1978 alone, but that for the wood processing sector is lower in spite of the beginning of a recovery towards the end of the period studied here. 1978 marked the first year of economic expansion in Finland after the recession of 1975—77, the GNP being 2.3% higher in real terms than in the previous years.

The correlations between the parameters in the simulation model vary somewhat, depending on whether the branch concerned relies on technology which is national or regional in origin (Table 12). The general profitability problems of capital-intensive industries are reflected in the fact that the correlation between the net rate of returns and capital requirements is negative at both areal levels. The correlation between mean gross returns (means of individual branches for the period 1974—79) and capital requirements, calculated in order to assess the influence of the depreciation allowance on the results, is —.234 for the 21 branches of industry represented in Northern Karelia and .308 for the whole country ($n = 27$). This suggests that the profitability of capital-intensive industries is particularly low in Northern Karelia.

The correlation between capital and power requirements is high at both areal levels, indicating that capital-intensive industries also entail an intensive use of power (Table 12). A high negative dependence between the net rate of returns and power requirements is also found at the na-

tional level, but this is not so marked in Northern Karelia (— .242). The negative correlation between labour and water input shows the difference between the labour-intensive and process industries.

Fixed capital per employee and returns to wage-earners are about the same in Northern Karelia as in Finland as a whole (Table 13), but salaries are lower in Northern Karelia, as is the ratio of salaried staff to wage-earners. One explanation for this is that many central office functions are absent from Northern Karelia (see section "Structure of production . . .").

Salary and wage levels vary more from one industry to another in this region than they do in the national economy as a whole, the average wage in the resource-based industries of Northern Karelia (SIC 2, 31, 331, 341, 36 and 4) in 1978 being 33 721 FIM per year compared with 27 858 FIM in the resource-independent industries, while average salaries were 43 221 FIM and 41 758 FIM respectively, both sets of figures showing incomes to be higher in the resource-based sector. These mean salaries and wages are obtained simply by dividing the total salary and wage bills by the numbers of staff and workers respectively (SVT XVIII: A 99).

Both the maximum and the minimum salaries and wages in the region are recorded in resource-independent industries, although marked variations are also found in the resource-based industries, wages and salaries in mining and the

Table 13. Fixed capital (1000 FIM) per employee and salaries and wages (FIM in year). * = Northern Karelian figures/national figures.

	Fixed capital/employee		Salaries		Wages	
	N-K	*	N-K	*	N-K	*
230 Ore mining	409	1.04	47 372	.88	39 894	.96
290 Other mining	1 176	4.43	46 667	1.09	40 700	1.28
311-2 Food manufacturing	137	.83	36 612	.84	28 732	.96
321 Manuf. of textiles	94	.55	38 432	.91	25 240	1.04
322 Manuf. of wearing app.	24	.73	33 775	.87	18 434	.84
323 Leather products	23	.25	45 000	1.07	19 600	.87
331 Wood (excl. furnit.)	361	1.81	42 556	1.00	30 210	1.05
332 Furnitures and fixtures	71	.79	34 039	.85	26 957	1.00
341 Paper and paperproducts	640	.88	49 147	.93	37 969	1.02
342 Printing and publishing	67	.69	44 510	.89	33 523	.91
351 Industrial chemicals	586	1.10	59 333	1.20	32 316	.96
352 Other chemical prod.	17	.09	35 000	.75	23 833	.84
355 Rubber products	245	1.06	52 000	1.14	28 189	1.05
356 Plastic products	152	1.33	47 375	1.02	28 058	.98
369 Pottery, china	77	.29	37 782	.81	39 071	1.21
371 Iron, steel basic	107	.20	45 000	.90	24 568	.66
381 Fabricated metal pr.	69	.66	43 107	.94	31 468	1.00
382 Machinery	109	.96	42 012	.90	32 490	.95
383 Electrical machinery	51	.39	57 000	1.22	25 152	.82
384 Transport equipment	135	1.38	41 214	.87	40 628	1.10
385 Instruments	66	1.25	—	—	31 000	.98
390 Other manufacturing	108	1.96	43 200	.94	28 965	1.00
410 Electricity and steam	426	.37	42 259	.88	35 034	.94
420 Water works and supply	56	.27	31 800	.68	39 556	.98
Total (2—4)	255	.99	42 586	.91	31 540	.99

manufacture of pulp and paper, for example, being above the average while those in food processing and the sawn timber industry are below average. Since wage and salary levels are not correlated, there is no dependence between wage levels and salary levels in individual industries. The correlation between wage levels and net rate of returns is $-.37$ and that between salary levels and net rate of returns $-.33$.

Fixed capital per employee also varies from one branch to another, and large differences in capital requirements exist between industries. No systematic difference in level is to be found compared with the situation in Finland as a whole, however. The high capital coefficient for other mining denotes the beginnings of peat production, while the resource-processing industries as a whole carry a heavy capital requirement burden. Power and water supplies require less capital investment in this region than in Finland as a whole, chiefly due to the prominent role of hydro-electric power, since its capital requirement relative to the value of the product is only about

a half of that encountered in a thermal power station (SVT XVIII A: 101).

To summarize the deviations of the results for Northern Karelia from the corresponding values for Finland as a whole, a comparison may be performed using the simulation model. When equal quantities of the labour force are allocated to the respective industries in the whole of Finland as in Northern Karelia, 20% higher net returns are obtained, indicating that the same mix of industries as is found in this region is markedly more profitable at the national level. Fixed capital is roughly equal in both, the difference being only 0.2%.

Power requirements are 22% higher at the national level, due to differences in the production of pulp and paper, there being more supplies of power from independent generators to wood processing mills at the national level than in Northern Karelia, but the demand for water is 11% lower. This latter fact does not necessarily mean any great difference in the use of water, since a considerable proportion of the water used

in wood processing is obtained from sources other than the water supply services.

The wage sum in the new industries (SIC 32, 35 and 38—9) would be 4% higher nationally if the same numbers of wage-earners were employed in the respective industries as in Northern Karelia in 1978, although the resource-independent industries seem to obtain only limited benefit from the lower wage level as a location factor. The content of the labour input is also different, in that the number of salaried persons on a national scale is 21% higher and that of wage-earners 3.5% lower. At the same time salary levels are 9.6% higher and wage levels roughly the same (+0.9%). This lower average salary and high proportion of wage-earners seen in Northern Karelia reflects the spatial division of labour at the intra-firm level. In summary, the comparison points to differences in profitability, the intensity of power utilization and the spatial division of labour between the economies of Northern Karelia and Finland as a whole.

A profitability-based alternative

In the first alternative to be examined (A), the economy of Northern Karelia is reorganized on profitability criteria. Given an unemployment rate in the late 1970's and early 1980's of between 6000 and 9000, it is assumed that some of these will be undergoing retraining and some will not be relevant to the manufacturing labour force. Of the 8900 unemployed in the region in 1978, 4100 were seeking industrial or unclassified work. Assuming that employment in manufacturing can be increased from somewhat below 12 000 to 16 000, to correspond to full industrial employment in 1978, this labour force is then reallocated in accordance with the profitability criterion (as expressed in the objective function). The capital invested is not expected to increase above the 1978 level. The results are shown in Table 14. Since the aim of the optimization is profitability, this projection may be referred to as the profitability-based alternative.

The model generates a much more profitable structure for industry in Northern Karelia than is the case at present. The neoclassical growth theories assume that an economy will move structurally and spatially towards the optimal (most profitable) structure in response to a disturbance impulse. How can such a wide deviation from the most profitable structure as is now found in the region be explained (Table 14)? Production is at

present concentrated to a great extent in branches responsible for processing natural raw materials to a low degree and with a slow rate of growth. In fact, both forestry and mining have experienced profitability problems, especially since the first oil crisis. Since one usually starts closing factories and investing in new sectors only when factories become worn out, the effects of declining profitability only begin to become apparent after a relatively long delay. On the other hand, the time available for the economy to adapt to this situation has been fairly short, as it was only with the regional policies and investments in infrastructure carried out in the 1960's that the ground was prepared for the growth of new industries in Northern Karelia.

The total outputs of other chemical products, rubber products and other manufacturing industries laid down in the profitability-based alternative are identical to the total output constraints, which implies a situation in which all manufactures in the whole country in these fields would take place in Northern Karelia. The most profitable solution would be to alter the total output constraint for other manufacturing industries, as shown in the shadow price. On the other hand, the output levels for printing and publishing and industrial chemicals are far from the national value, accounting for 2.5% of the national total in the former case and 0.8% in the latter.

The composition of the labour force changes markedly under this alternative, mostly due to the manufacture of other chemicals, although salary levels in this branch are slightly below the average. In spite of the considerable increase in the proportion of salaried persons, the figure still remains below that for Uusimaa today.

The stability of the results can be ascertained by using the net rate of returns coefficients from the years of economic expansion, 1974, 1978 and 1979, and those for the recession years 1975—77. The net returns using the coefficients of the former years are 847 mill. FIM, and the industries chosen by the LP model are the manufacture of industrial chemicals, other chemical products, rubber products, machinery (except electrical) and other manufacturing industries. In the recession years the most profitable structure for the economy would have consisted of tobacco products, furniture and fixtures, industrial chemicals and other manufacturing industries, giving net returns of 848 mill. FIM. This analysis involves a 81% increase in power requirements, caused by the very high use of power in the

Table 14. The profitability-based alternative, economic structure in manufacturing and allied industries (SIC 2—4) using constraints on employment, fixed capital and level of output. * = percentage change from actual 1978 level.

	Model		*	
Net returns (mill. FIM)	811		479	
Gross value (mill. FIM)	3 167		45	
Fixed capital (mill. FIM)	3 007		0	
Number of personnel	16 000		36	
Gross value of power sector (mill. FIM)	190		—2	
Gross value of water supply (mill. FIM)	7.34		—1	
Number of establishments	200		—1	
Number of salaried persons	5049		129	
Number of wage-earners	10925		15	
Sum of salaries (mill. FIM)	237		152	
Sum of wages (mill. FIM)	318		6	
Average salary (1000 FIM in year)	47		10	
Average wage (1000 FIM in year)	29		—8	

Industries	Net returns mill.		Gross value mill.		Person- nel		Fixed capital mill.	
	FIM	%	FIM	%	%		FIM	%
342 Print., publ.	30	4	124	4	774	5	75	2
351 Industrial chem.	3	0	35	1	48	0	28	1
352 Other chemicals	416	51	1 770	56	9 423	59	1 685	56
355 Rubber products	159	19	509	16	2 862	18	701	23
390 Other manuf.	176	22	531	17	2 211	14	239	8
410 Electricity and s.	22	3	190	6	649	4	276	9
420 Water supply	4	1	7	0	33	0	2	0
Total	811		3 167		16 000		3 007	

Shadow prices:			
Labour force	31 988 FIM	Other chemicals	1 FIM
Fixed capital	69 FIM	Rubber products	38 FIM
		Other manufacturing	167 FIM

Value unit in constrains (except labour force) is 1000 FIM.

Composition of labour force percentages:

	1978 actual	model	Uusimaa
Salaried persons	19	32	34
Wage-earners	81	68	66

manufacture of industrial chemicals. The differences between the expansion and regression years and the ordinary situation in terms of net return are less than 5%, and the industries in the models are all of the resource-independent kind, as in the basic situation (Table 14).

What would be the implications of development along the lines set down in this alternative? The industrial structure would change very dramatically if the resource-based industries were omitted, with less marked multiplier effects and more open industries. Dependence on the resource base would decrease and the region's

resources would be exported with no primary processing. This would mean in turn that the natural resource base would to a great extent fade in significance as the foundation of the region's industry. This would not necessarily mean a reduction in primary production of the same order as the decline in multiplier effects, however. It would merely mean that the cordwood or sawlogs at present processed in the region would be sent elsewhere for this purpose. In fact, reductions in the other resource-based industries such as dairying, slaughtering and other mining would have more pronounced repercussions for primary

production on account of the poorer facilities for transporting these raw materials outside the region.

The second issue, of course, concerns the infrastructure requirement of the new industries, including the training of the necessary labour force. The wood processing mills are large in size and are located in relation to supply and distribution conditions (raw materials transported by water and products by rail), and resource-processing industries in general call for an infrastructure which is adapted to the needs of the processing sector, in terms of power supplies, transport, water, etc. The new industries, in contrast, do not usually have such stringent infrastructure needs, and can be located more freely and in smaller units.

The model shows a very different kind of Northern Karelia, one which has undergone a transition in economic structure towards a less resource-based mix of industries, although the change can be assumed to take place gradually and act as a continuation to the relatively rapid development which followed the implementation of regional policy stimuli in the late 1960's. One condition for the continuation of this line of development would nevertheless be that the new industries should consistently exceed the resource-based ones in profitability. Also, it should be remembered that restructuring of industry and the introduction of new industries is simultaneously taking place elsewhere in Finland and abroad, creating a state of competition and placing restrictions upon development of this kind.

It would be wrong, however, to regard a powerful contribution from the resource-based industries as a detrimental feature. Only the mining of mineral ores appears to entail insurmountable restrictions, in the form of exhaustion of existing ore deposits. Forestry is invaluable because of the employment it offers, and the encouragement of local wood processing industries would undoubtedly mean more intensive exploitation of the natural resources in this sphere (including small-sized timber). Also, some of the income achieved by the wood processing companies is transferred to the local population in the form of stumpage prices. For much the same reasons the foodstuffs industry is important by virtue of its multiplier effects, since a higher proportion of the active working population are employed in farming than in the whole of the industrial sector combined.

To summarize the results of applying this model, it may be stated that following the first

oil crisis it would have been more profitable for Northern Karelia to have specialized in resource-independent industries, those which represent the most expansive and viable part of the economy. On the other hand, the reduction in resource-based industries allowed for by the model and the growth in the new industries do not entail mutually compatible effects on employment, the new industries being unable to compensate for the resulting primary sector unemployment, forcing an increase in the direct exportation of primary sector products from the region.

A resource-processing alternative

The exploitation and processing of natural resources is frequently looked upon as a sector of production which it is particularly important to develop in the case of Northern Karelia (Pohjois-Karjalan . . . 1978; Pohjois-Karjala . . . 1980). The next scenario to be tested assumes full use of local resources and calculates the implications of such an alternative. This may be referred to as the resource-processing alternative (B). Again certain assumptions are made:

Mining: It is assumed that the level of mining will decrease to close to the national level. The region was still producing about 30 % of Finland's metal ores in 1978 (SVT XVIII A: 99), with almost the whole of its labour force deployed in mines scheduled for closure during the present decade. The assumption is that about 200 persons will continue to be employed in mining, amounting to about 4 % of the total labour force in this sector in Finland. This would enable one small mine to be kept open with a profitability close to the national level.

Other mining: This heading covers both quarrying and peat extraction, of which the latter was still recording negative returns when in its initial stages in the 1970's. This sector of other mining employed about 200 persons in the early 1980's, and it is assumed that such a level will be maintained, and, very optimistically, that levels of profitability and technological progress will remain up to national standards.

Food processing: The characteristics of the food processing industry are a low value added and below-average profitability. Traditional agricultural production can be expected to remain at roughly the current level in the next 15 years or so, and although rationalization in the food industry can be expected to reduce the numbers employed, this could be offset, at least in the long

term, by increasing the level of processing and opening up new lines of production. It should be possible to start processing new raw materials such as fish, berries and some agricultural products in addition to the current range of milk, flour etc. Thus the decrease in the labour force in this sector should not occur on the scale at one time expected. For the purposes of the present model employment is assumed to remain at around the 1978 level of 1578 persons and profitability to be close to the national average.

Manufacture of wood products: This covers chiefly the sawmill industry and allied branches. Input to this sector in 1978 was 1.25 million cubic metres of large-sized timber (Huttunen 1981: 23). It is assumed in the model that virtually all the large-sized timber in the region will be used for this purpose so that if the permitted cut is 2 million cubic metres a year, some 1.9 million cubic metres will be available (Jaakko Pöyry . . . 1981: I/25). This implies an increase of about 52 % in the local processing of large-sized timber, which taking profitability and technological progress to be of the same order as in the country at large, and would imply a labour force of 3143 persons.

Pulp and paper: The industrial input of cordwood in 1978 was 0.56 mill. cubic metres and that of wood residues 0.17 mill. cubic metres (Huttunen 1981: 23). According to the calculations of Pöyry, about 1.9 mill. cubic metres of cordwood are supplied for industrial use each year (Jaakko Pöyry . . . 1981: I/25). These calculations also assume that a further 300 000 cubic metres will be consumed in other uses. In addition, wood chips are produced mainly as a by-product of the sawmill industry, the majority of which, some 500 000—600 000 cubic metres, are exported outside the region (Jaakko Pöyry . . . 1981: I/17). It is assumed here that the input of cordwood to the pulp and paper industry will be 2.1 mill. cubic metres, on the grounds that all the cordwood intended for industrial use will then be utilized and an additional 200 000 cubic metres can be obtained by reducing the other uses made of cordwood or reducing the exportation of chips. A large proportion of the chips can still be used in the manufacture of chipboard or other wood products excluding furniture. Pulp and paper manufacture in Northern Karelia suffers from many drawbacks associated with technical problems, its range of products and profitability considerations, and it is assumed that these can be rectified, whereupon production technology would be at the national level, as would the

range of products and their quality. The output from this sector would then have a value of 1264 mill. FIM and employment be 3636 persons.

The sum of the outputs from the manufacture of wood products other than furniture and the manufacture of paper and paper products under this scenario would be 8.2% of the figure for the whole country and the labour force employed 7.6%. This corresponds well to an annual permitted cut from the forests amounting to 7.9% of the total for the whole country.

Mineral products: Mineral products in Northern Karelia consist mainly of supplies to local construction industries and exports. The resource base for this is good, and it is assumed here that the level of production will remain at that recorded in 1978. The employment effect of this would be 402 persons, given existing conditions of profitability, technology and industrial mix.

When the effects of full exploitation of the region's natural resources are ascertained using the simulation model (equations 21—30), the capital requirement is seen to increase above the 1978 level but the labour requirement to remain below the target level, at only 9159 persons. The optimization model may then be used to project full employment and add further industries to the region's economic structure. This then gives a total labour force of 16 000 assuming a restriction of 1747 mill. FIM upon capital investment in the additional sector, a figure which would give the same average capital/labour ratio for industries in the region as in 1978.

The results obtained with the resource processing alternative (Table 15) differ markedly from those given by the profitability alternative (Table 14), since it is based on full use of local resources and the benefits to be gained from organizing production to be close to the sources of its raw materials and from inter-industry links, etc. (Smith 1981: 406—422). The implications of such a development strategy applied to local resource processing in Northern Karelia are a high level of power consumption and high fixed capital requirements. At the same time the sum of the net returns from the resource processing industries is —2 mill. FIM, the positive sum of net returns obtained overall being the outcome of returns in the resource-independent industries. The difference in profitability between the two alternatives is a considerable one (Tables 14 and 15), but it should be remembered that it only concerns the industrial sector, and that the resource processing alternative entails a high level of output from agriculture and forestry, which are im-

Table 15. The resource processing alternative. * = percentage change from actual 1978 level, ** = percentage change compared with the profitability-based alternative.

	Model	*	**
Net returns (mill. FIM)	436	211	-46
Gross value (mill. FIM)	5 448	150	72
Fixed capital (mill. FIM)	6 683	122	122
Number of personnel	16 000	36	0
Gross value of power sector (mill. FIM)	503	160	165
Gross value of water supply (mill. FIM)	7.38	0	1
Number of establishments	279	37	40
Number of salaried persons	3 127	42	-38
Number of wage-earners	12 832	35	17
Sum of salaries (mill. FIM)	1567	66	-34
Sum of wages (mill. FIM)	418	40	31
Average salary (1000 FIM in year)	50	17	6
Average wage (1000 FIM in year)	33	3	14

Industries	Net returns mill.		Gross value mill.		Person- nel		Fixed capital mill.	
	FIM	%	FIM	%		%	FIM	%
230 Metal ore	-.5	0	23	.4	200	1	79	1
290 Other mining	4	1	29	.5	200	1	53	1
311 Food pr.	44	10	569	10	1 578	10	26	04
331 Wood pr.	38	9	674	12	3 143	20	1 133	17
341 Pulp., pap.	-96	-22	1 264	23	3 636	23	2 645	40
351 Ind. chem.	170	39	1 703	31	2 359	15	1 382	21
355 Rubber pr.	29	7	92	2	515	3	126	2
369 Mineral pr.	7	2	51	1	402	3	31	.5
390 Other manuf.	176	40	532	10	2 211	14	239	4
410 Electricity	59	14	503	9	1 723	11	733	11
420 Water supply	4	1	7	.1	33	.2	2	.02
Total	436		5 448		16 000		6 683	

Shadow prices:

Labour force	43 540 FIM	Other manufacturing:	128 FIM
Fixed capital	49 FIM		

Value unit in constraints (except labour force) is 1000 FIM.

Composition of labour force, percentages:

	1978 actual	model	Uusimaa
Salaried persons	19	20	34
Wage-earners	81	80	66

portant sources of income in the region.

The proportion of wage-earners in the resource-independent part of the economy continues to be high under this scenario, on account of the other manufacturing industries, in which this proportion is very high, and the average wage is also higher than in the first alternative, mainly due to the high wage levels prevailing in most resource-processing industries.

This alternative implies a total labour force in the resource-processing industries plus power and water supplies of about 10 000 together with 6 000 in the new industries. The extent to which this may be considered a realistic alternative is limited, however, by the assumption of a fixed level of technology and the continuation of the same range of products in every branch as in the year on which the projection is based. On the

other hand, it is true that the range of products resulting from the processing of natural resources has not changed very much in the region over recent decades, and the resource periphery contains mainly adopters of new technology, so that if resource-based production has been developed in the region to the extent presupposed in the model, the technology employed would probably indeed have been much of the kind assumed here.

The results obtained with this alternative demonstrate that a resource periphery offers few opportunities to solve existing economic problems by developing the traditional branches of industry by conventional means of resource processing. Changes in agriculture and forestry and technological progress in the resource processing industries can all be expected to leave an increasingly large part of the labour force to seek jobs in the new industries or the service sector, or to remain unemployed. Increasing resource use and processing, as allowed for by modern technology, cannot guarantee full employment, as this alternative model shows. Even when the national net return parameters are used, profitability in most of the current resource processing industries remains below the level in the new industries.

An increase in the resource-processing sector of the extent assumed in this model would not have sufficed to solve the problems facing Northern Karelia in the 1970's. There may be many reasons for preferring such an approach, but the profitability and employment effects achieved remain at very modest levels.

Although the results obtained using the optimization model are highly fictitious in nature, it is clear that they assign a preferred status to the new industries. The adoption of such industries in the 1970's was undoubtedly justified in economic terms. Such industries are relatively free in their locational possibilities. As Luttrell (1962) points out, "about two-thirds of British manufacturing industries can operate successfully in any of the main regions of the country". Industrialization has brought many new branches of production to the development regions of Finland, stimulated by the infrastructure improvements and regional policy measures of the 1960's and later, and this was seen in the 1970's to have been well justified as a developmental strategy from the points of view of profitability, capital requirements and environmental loading.

The schema put forward above, 1) comparison with the national economy, A) the maximum profitability alternative, and B) the full resource

use alternative, serve to highlight the significance of the structural problem facing the economy of Northern Karelia. Technological progress has greatly reduced the changes of providing the population with full employment within the framework of resource-based production, for it is clear that specialization in the conventional processing of the region's own natural resources rather than the introduction of new industries would not have been able to guarantee full employment under current conditions of technological progress, while at the same time the impact on the environment would have been many times greater than that actually experienced in the 1970's. In spite of its rapid industrialization, however, Northern Karelia has not been able to achieve national levels in terms of profitability and most other economic measures, due to a considerable degree to the problems experienced in the resource-processing industries and to the consequences of the spatial division of labour.

Fictive growth — up to the year 2000

It may be assumed that the transition in the structure of the economy in Northern Karelia will continue throughout the 1980's and 1990's, at least in the form of a reduction in the proportion of the active working population engaged in the primary sector, even though this reduction may be much slower in absolute figures than that which took place in the 1960's and 1970's. This will naturally be associated with an increase in those employed in industry and especially in the service sector (Table 10). Service sector employment can be expected to increase in SIC class 9, but no marked changes can be envisaged in the other subcategories. This assumption regarding expansion in the service sector will place particularly great pressure on the public services, as most of the jobs in class 9 are in the public sector.

It is predicted officially that employment in industry will be around 16 000—18 000 persons by 1995 (Table 10), a figure which may be regarded as a regional policy goal capable of achievement given the existing competitive climate and existing regional development measures. The lower of these figures is in fact of the same order as that given by the present model, when we remember that a few hundred persons should be added to the sum indicated in the model to represent employment in companies with a staff of less than 5, which are not included in the Industrial Statis-

tics employed here. The results obtained with the optimization model allow an assessment to be made of the developmental alternatives available in the medium term.

As we move from counterfactual situations to future predictions, we can expect changes in the parameters of the linear model with time. The productivity of labour is increasing all the time with advances in technology, just as more intensive use is being made of power resources. The mean annual increase in productivity in Finland in the long term, over the period 1900—1975, has been 2.7%, with a somewhat sharper increase in recent years, 4.5% per year between 1961 and 1975, the highest achieved over any period of comparable length (Lahtinen 1977: 43—45).

Power consumption, expressed in terms of a power consumption coefficient, indicating the power needed per unit of output, has also increased in the long term, but has decreased from 1960 onwards. With labour input being constantly replaced by increased power input, however, the power intensity, expressing power consumption as a function of labour input, has increased steadily over the whole period 1900—1975 (Lahtinen 1977).

In view of the increase in productivity, the employment level of 16 000 persons requires a higher total output than is allowed for by the model. But technological progress also affects power consumption and capital requirements, in a manner which is difficult to take into account in the model, as individual technical arrangements implemented at large factories in the resource-processing sector can have significant overall effects on the measures reflecting the nature of the whole regional economy. Bearing this area of uncertainty in mind, the results given by the model are adequate provided they are interpreted as providing indications of a trend and nothing more.

The projection made by the office of the Council of State for development in Northern Karelia (Lääneittäinen ... 1982) may be assessed by comparing the predicted number of industrial employees in this region with the figures for other provinces of Finland in 1978. In the light of these 1978 figures, employment in industrial sectors (SIC) 2—4 in Northern Karelia would be 19 500 persons based on the degree of industrialization in the country as a whole, 19 600 persons based on the degree in the province of Uusimaa, and 27 500 persons based on the degree in the most industrialized province of all, that of Häme (SVT XVIII A: 99). Since employment in industry has

scarcely increased at all since that time, these may be regarded as maximum values.

The increase in industrial employment in Northern Karelia over the period 1970—82 was 4.2% a year, which, if rounded off to 4% per year, would suggest that the degree of industrialization prevalent in the province of Uusimaa and the whole country in 1978 would be achieved in this region in the early 1990's and that now found in Häme by the year 2000. If one were to take the growth figure for the recession period of 1975—77, the situation in Uusimaa and the whole country would be achieved by 1995 and that in Häme by around 2005.

An increase in industrial employment to the level of 19 500—19 600 represented in 1978 by the whole country and the province of Uusimaa would imply a 2/3 increase in relation to the figure for this sector (SIC 2—4) in 1978. If we assume a 4.5% increase in productivity, in accordance with the general trend, and an increase in employment of 4% per year, we have a situation in which production would have to increase from 2180 mill. FIM in 1978 to 6500 mill. FIM by the early 1990's.

It may be noted for the sake of comparison that the figure of 16 000 used in the evaluation model already implies an increase of 36% over the figure for 1978. If we assume an increase in employment of 4% per year and an increase in productivity of 4.5% per year, production would have to almost double (increase by 96%) in order to achieve even this rise of 36%.

Although such speculation based on growth trends places industrial growth in Northern Karelia in perspective in relation to the degrees of industrialization and improvements in productivity achieved in the industrial south of Finland, it will not serve as a prediction, for it is the ability of the production system to respond to market demands, the measures taken in the fields of economic and regional policy and the extent of the competition from other areas that will in the last resort determine what volumes of products are exported and to what extent the employment goals are reached.

The assignment of priorities to alternative courses of industrial development is problematical, so that in effect it would be profitable to maintain production only in a small number of new industries, basically the combination of five branches listed in the results of the profitability-based model above (Table 14). If one were to relax the constraints, how many new branches could one chose from, and would any resource-

processing industries be included? The linear programming model will be operated in a stepwise manner below in order to demonstrate what types of industry would be chosen on the profitability criterion alone. Here the capital requirement is allowed to increase in the same proportions as in 1978, but the maximum production constraints are retained, in order to show to what extent limits based on total production in the national economy constitute barriers to expansion in given branches of industry.

The optimal combinations of industries calculated for total industrial employment figures of 11 774—65 000 are indicated in Fig. 22, in which the broken line AC denotes the amount of the net returns as a function of total employment as the stepwise optimization advances. Note that the increase in net returns slows down as the national production totals begin to place limits upon growth in certain industries. The line AB describes a situation in which expansion takes place entirely in terms of production in branches 11, 12, 21 and 33, the proportions of these remaining constant. The retarding effect of the nationally determined production constraints is then shown by the difference between AB and AC.

The line DE on the same diagram denotes the expansion achieved in the economy of Northern Karelia by comparison with the situation in 1978, on the assumption that the structure of the economy remains the same as in that year. The interval AD then represents the difference in net returns between that initial year and the optimized situation, which amounts to some 500 mill. FIM. Thus, taking the employment figure and capital requirement for 1978, it would be possible to achieve net returns more than four times that actually achieved in that year by means of the combination of industries indicated in the optimization solution. The result is a speculative one, of course, but it serves to emphasize the profitability problem inherent in the economic structure of the region and the inflexibility of this system to change.

The results given by the model indicate that economic development is weighted on the side of the new industries (Fig. 22), for it does not take into account production in the traditional resource processing sectors at all. The shaded area in the figure denotes the maximum volume of production in each industry, i.e. the point at which it reaches the volume produced in the national economy in 1978. This limit would be reached in the case of rubber products and other industrial products with a total industrial employ-

ment of just under 15 000 persons, assuming the level of technology to be that prevailing in the region in 1978, while in the case of other chemical products the limit would be reached with a total industrial employment of 20 000 and in that of tobacco products at 25 000. Northern Karelia would be producing the country's entire output of chemicals at a total employment figure of 30 000. These stepwise optimization results indicate that the production figures achieved in the national economy are indeed large compared with the production potential of Northern Karelia.

A further aim of the stepwise optimization procedure was to examine the development problem in Northern Karelia in its national perspective, for which purpose interpretation of the results naturally requires account to be taken of the real-world situation. It is probable that the increase in industrial employment in the region will slow down from what it was in the 1970's, as is usually the case as industrialization advances, but it is still highly uncertain at what level it will settle. The projection commissioned by the office of the Council of State expects it to level out at a figure well below the rapid growth rate recorded in that decade, but progress in industry is very substantially dependent on general economic development and measures taken in the fields of economic and regional policy, and such factors could well have a considerable effect on the final outcome.

The same Council of State projection forecasts that industrial employment will not reach the 18 000 mark by 1995 (Lääneittäinen . . . 1982), implying a maximum growth rate of no more than a few thousand jobs over the whole 10—15 year period, these being concentrated primarily in the new industries. Also, the structural changes and economic growth allowed for in the projection are based on the existing structure of industry, i.e. it is assumed that the majority of the factories and companies functioning in the region at present will still be doing so by the end of the period concerned. Calculated in this way, the net gain in employment opportunities is no more than a half of the employment figure prevailing at the beginning of the projection period.

It is true, of course, that the whole economy of Northern Karelia operates on such a small scale that any structural changes would have very little impact of industrial production nationally. Consequently the creation of new industries there or the transfer of such from other places would not mean any major upheaval in the sectoral pattern of spatial specialization within the country

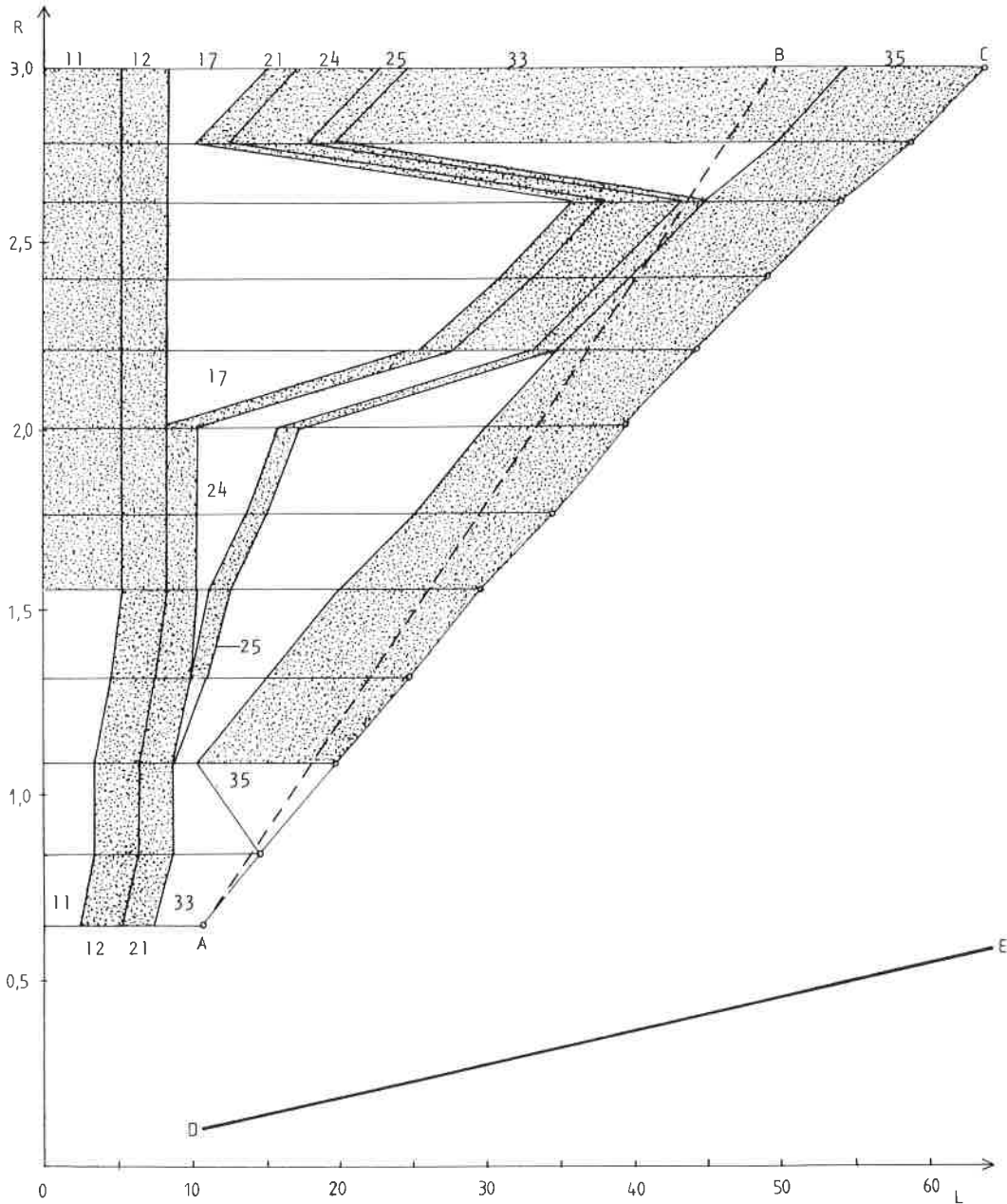

Fig. 22. Selection of branches of industry in stepwise linear programming. R = net returns (1000 mill. FIM), and L = employment in industry (1000 persons). Branches: Based on technological levels in Northern Karelia: 11 = chemicals, 12 = rubber goods, 17 = machinery, 21 = other manufactures. Based on national technological levels: 24 = beverages, 25 = tobacco products, 23 = printing and publishing, 35 = other chemical products. Shaded area = employment equivalent to the total figure for that branch in the national economy.

as a whole, even if growth were restricted to just a few sectors, e.g. those pointed out in the model as being the most profitable. The result given by

the model also suggests that profitability decreases relatively slowly as a function of employment in the sector concerned, so that

Table 16. Economic structure for Northern Karelia favoured by a group of senior executives and professional people (Group A) in May 1983.

1.	2.	3.	4.	5.	Employment in industry no. (SIC code):										
					2	31	32	33	34	35	36	37	38	39	Total
1)	1	410	3	33						11 300			4 000		15 300
2)	1, 4	810	2	32			1 300			2 000			10 000	2 000	15 300
3)	1	911	2	31		1 000	1 000	500	2 500	500	1 000	500	8 300		15 300
4)	4	810	2	32		1 465	2 735		1 500	4 000			5 600		15 300
5)	1	627	3	35	400	2 800	3 500	4 500	1 100	700	50	50	2 000	200	15 300
6)	3	311	4	33	500	1 500	1 500	2 500	4 000	1 200	100	1 000	2 500	500	15 300
7)	2	931	2	37	800	1 000	2 500	2 100	1 200	1 400	500	200	5 300	300	15 300
8)	3	932	1	36		1 700	500		6 300	2 700			3 100	1 000	15 300
9)	1	711	3	37		2 000	2 000	3 000	3 000	2 000			3 300		15 300
Mean					188	1 273	1 671	1 400	2 178	2 422	628	194	4 922	422	15 298
1978					1 273	1 578	1 225	2 261	1 840	481	402	51	1 821	146	11 078
% change					-85	-19	36	-38	18	404	56	280	170	189	38

1. = no. of respondent, 2. = respondent's profession: 1 = office manager status, 2 = teacher, 3 = laboratory engineer or technician, 4 = lawyer 3. = respondent's branch of industry (SIC code) 4. = respondent's education: 1 = doctorate or licenciate, 2 = master's degree 3 = first degree, 4 = technical college qualification, 5. = age of respondent (in yrs).

branches that were preferable for reasons of profitability could be selected from the whole range offered by the model without any substantial fluctuations in profitability, always presupposing, of course, that the profitabilities of individual companies behave in the manner predicted by the relevant figures in the overall model.

Subjective evaluation

Implementation of the subjective evaluation

Since an economy is changing constantly with market fluctuations and technological advances, it is impossible to predict the future with complete accuracy. The results of the optimization procedures undertaken here are based on parameters estimated from past data, which in itself places limitations on the relevance of such a model to any evaluation of future prospects. Also, decisions made in the economic sphere are grounded upon various estimates and ideas concerning successful economic activity, and at the same time carry with them subjective elements reflecting preferences, market expectations, etc.

Alongside linear programming, the present research also makes use of subjective evaluation to generate different courses of economic development. The aim of this is to examine what directions in development are preferred and whether the results of such an evaluation deviate markedly from those given by the optimization

program. This subjective method is intuitive in nature and departs radically from the optimization program in its basic assumptions (Chadwick 1971). In the present case it was performed by setting two groups of experts the task of planning an ideal structure for the economy of Northern Karelia. They were asked what branches of industry should in their opinion be represented in the region and what should be the size of each in terms of the number of employees. Selections could be made assuming a level of technology in each branch which was equivalent to that prevailing either nationally or in Northern Karelia. Each respondent answered separately, indicating his preferred level of employment in each of 48 branches of industry, up to an overall total of 15 300 giving a final figure of approx. 16 000 employed in the industrial sphere allowing for those engaged in power, heat and water supplies. This figure corresponds to the total employment constraint placed upon the alternatives generated by the optimization program. Solution of equations 24 for total output with the employment figures given then enable the other equations in the simulation model to be solved, so that this model can be used directly to calculate the spin-off effects.

Apart from the fact that they were told beforehand that one of the criteria for evaluating the results would be profitability, the respondents were able to define the goals of their ideal economy and justify their preferred structures in whatever way they wished. The results are valid for comparison with those yielded by the optimization

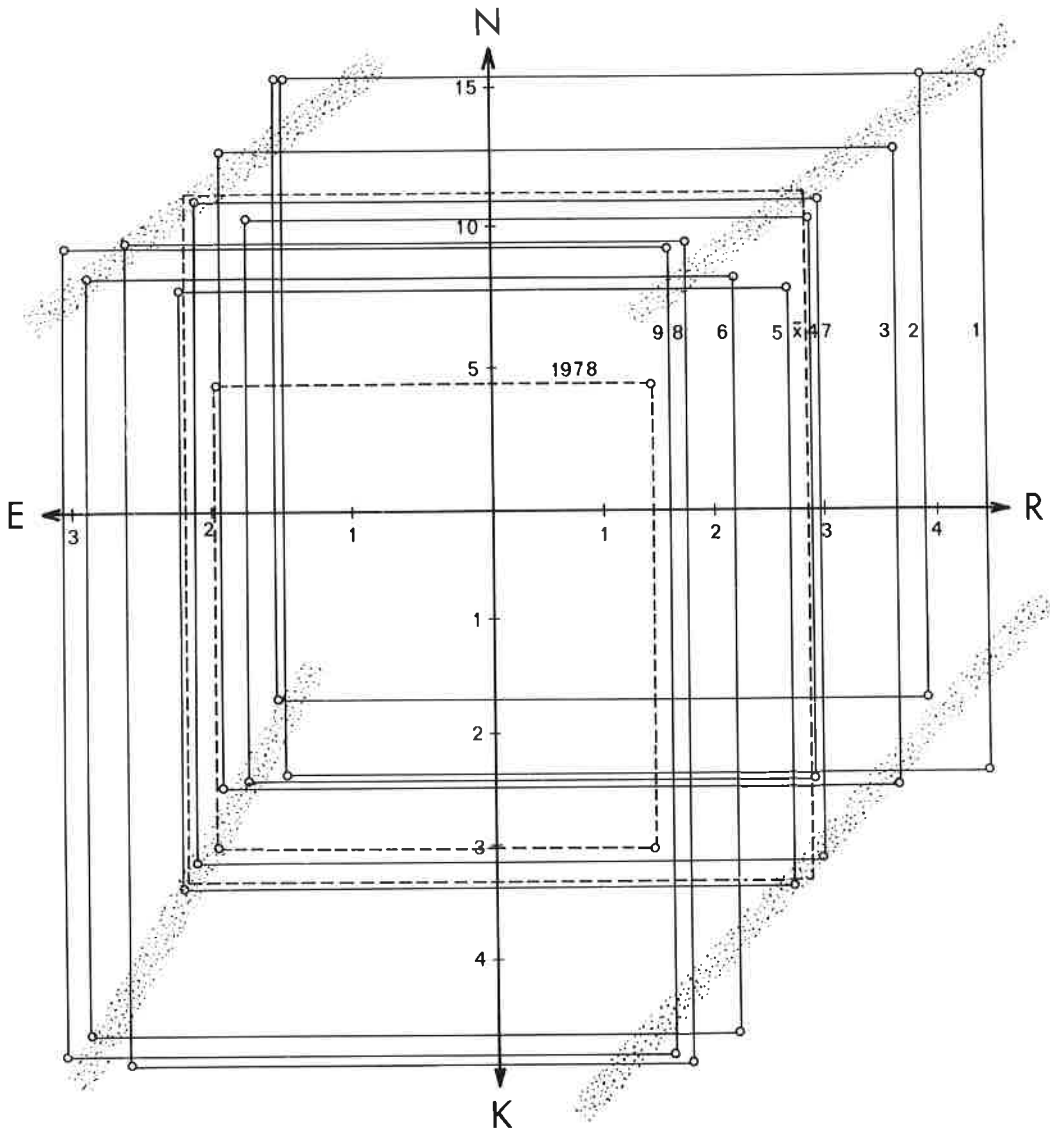

Fig. 23. Employment in resource-independent industries N (1000 persons), net returns R (100 mill. FIM), capital K (1000 mill. FIM) and total output of electricity and heat E (100 mill. FIM) in the alternative economic structures proposed by Group A. Correlations at $p < .01$ are indicated by the shaded lines. The resource-independent industries are nos. 4–6, 8, 10–13, 15–21, 24–29, 31, 33–39 and 41–48 in Appendix 4.

model, since they allow for the same level of employment as in both the profitability and resource-based alternatives.

Results of the evaluation

The first group of experts used for this purpose, Group A, comprised senior executives in various forms of business, with a mean age of 34 years and a high level of education (Table 16).

Their mean preferred economic structure consisted predominantly of new industries, and they were in general prepared to reduce production in the resource-based sector, although certain members (nos. 5, 6, 8 and 9 in the Table) strongly preferred to develop the wood processing industry in particular.

The results obtained from this group are depicted in Figs. 23 and 24, where the number-

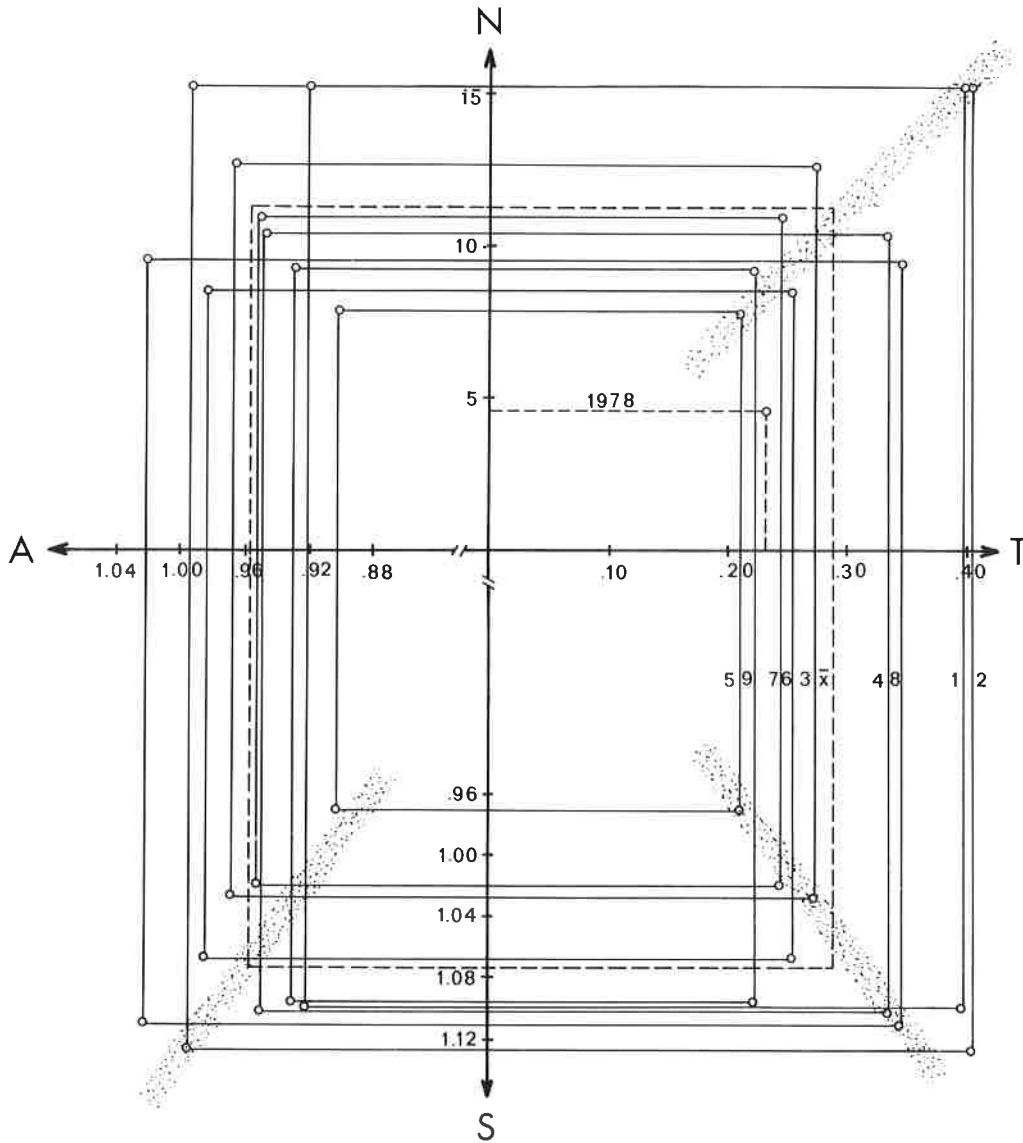

Fig. 24. Structure of employment and wage and salary levels in the alternatives proposed by Group A. N = employment in resource-independent industries (1000 persons), T = ratio salaried staff/wage-earners, S = ratio of mean salary to that in 1978, A = ratio of mean wage to that in 1978. Correlations at $p < .10$ are indicated by the shaded lines.

ing of the members corresponds to that in Table 16. Members 1 and 2 would invest entirely in new industries, whereas the others would also use part of their employment quota in the resource-based sector. Respondent 3 would retain the wood processing industry, but at a lower level than in 1978, and concentrate investments in the metal-working industries. Respondent 5, on the other hand, would make considerable investments in

the wood processing sector, but chiefly in the further processing of the products, i.e. non-metal furniture production and the graphics field. The greatest investors in wood processing as such would be nos. 9, 8 and 6, who produced plans which would entail high capital and power requirements. One person, respondent 8, also proposed the establishment of a chemicals factory in connection with wood processing.

Table 17. Economic structure for Northern Karelia favoured by a group of students (Group B) in October 1983.

1.	Employment in industry no. (SIC code):									Total	
	2	31	32	33	34	35	36	37	38		39
10)		900	2 200	2 300	500	3 100	500	50	5 750		15 300
11)			3 900	3 500	5 500	100	750	350	1 200		15 300
12)	300	3 650	2 600	1 400	800	1 500	200	500	3 350	1 000	15 300
13)	50	3 500	2 600	700	400	2 100	600		5 350		15 300
14)	100	800	700	1 200	2 800	4 100	200		5 200	200	15 300
15)	400	4 500	2 400	1 500	600	700	300		4 900		15 300
16)	100	2 700	2 900	3 100	1 500	1 300	700	400	2 600		15 300
17)	100	5 000	2 700	2 500	650	100	1 000		3 150	100	15 300
18)	1 900	1 000	1 900	3 300	1 700	1 900	800		2 400	400	15 300
Mean	328	2 883	2 389	2 389	1 006	1 728	478	144	3 767	189	15 301
1978	1 273	1 578	1 225	2 261	1 840	481	402	51	1 821	146	11 078
% change	-74	83	95	6	-45	259	19	182	107	29	38

The correlations between the variables may be seen from the distribution of the sets of points in Fig. 23, the structural combinations achieving higher net returns the more they devote their labour resources to the new industries and lower net returns the more capital-intensive their industries are, due to the poor profitability of the process sectors. Power requirements are very obviously dependent on how capital-intensive the production is and to what extent the economy relies on resource processing industries.

The outcomes vary greatly depending on what branches of industry are preferred, the only parameter which is controlled being the increase in employment, set at approx. 36%. Thus total output of electricity and heat varies from -19% to +60% in relation to the situation in 1978, the mean increase being less than that in employment. In fact the electricity and heat used in industry alone varies over a still greater range, as the figure calculated by the model also includes consumption in the primary and service sectors, which is assumed to remain constant (equation 22). The growth in net returns varies from 14% to 218% depending on the alternative chosen, and that in the capital requirement from -22% to +64%.

The alternatives differ somewhat in their effects upon the structure of employment and wage levels (Fig. 24). The new industries are usually more heavily accented towards salaried staff than the resource-processing sector, and the higher mean salary level is due to the fact that Group A tended to prefer the chemicals and metalworking industries, in which salaries are higher than in the economy of Northern Karelia in general. All the alternatives presented involve an increase

in salary levels except for that of respondent 5.

Wage levels, on the other hand, are estimated to drop to 96% of the 1978 figure as a consequence of the change in the industrial mix, chiefly due to a decrease in production in certain highly paid fields, notably the mining of ores and pulp manufacture. A further contributory factor is the number of branches of the new industries which have low wage levels, reducing the mean wage in most of the schemes proposed (Fig. 24).

Group B consisted of advanced students of regional planning at the University of Joensuu. These people had received better information in advance on the structure of the economy in the region as a result of a 56-hour course of teaching on the subject, at the end of which they were asked to plan an ideal structure for this economy. The time horizon was set at 10-15 years into the future, their task being to describe the ideal structure of the economy at the end of this period.

The students in Group B located more of their employment quota in the resource-processing sector than did the senior staff in group A, an average of 6179 persons compared with 4234, including an increase of over 1000 persons in the food processing industry relative to the initial situation. The reasons given for this were that much greater diversity ought to be attained in the region's agriculture and that industries should be created to process the more specialized products further and direct the eventual foodstuffs more towards the export market. In contrast, three out of the nine respondents thought it appropriate to reduce the numbers employed in the food processing industry (Table 17).

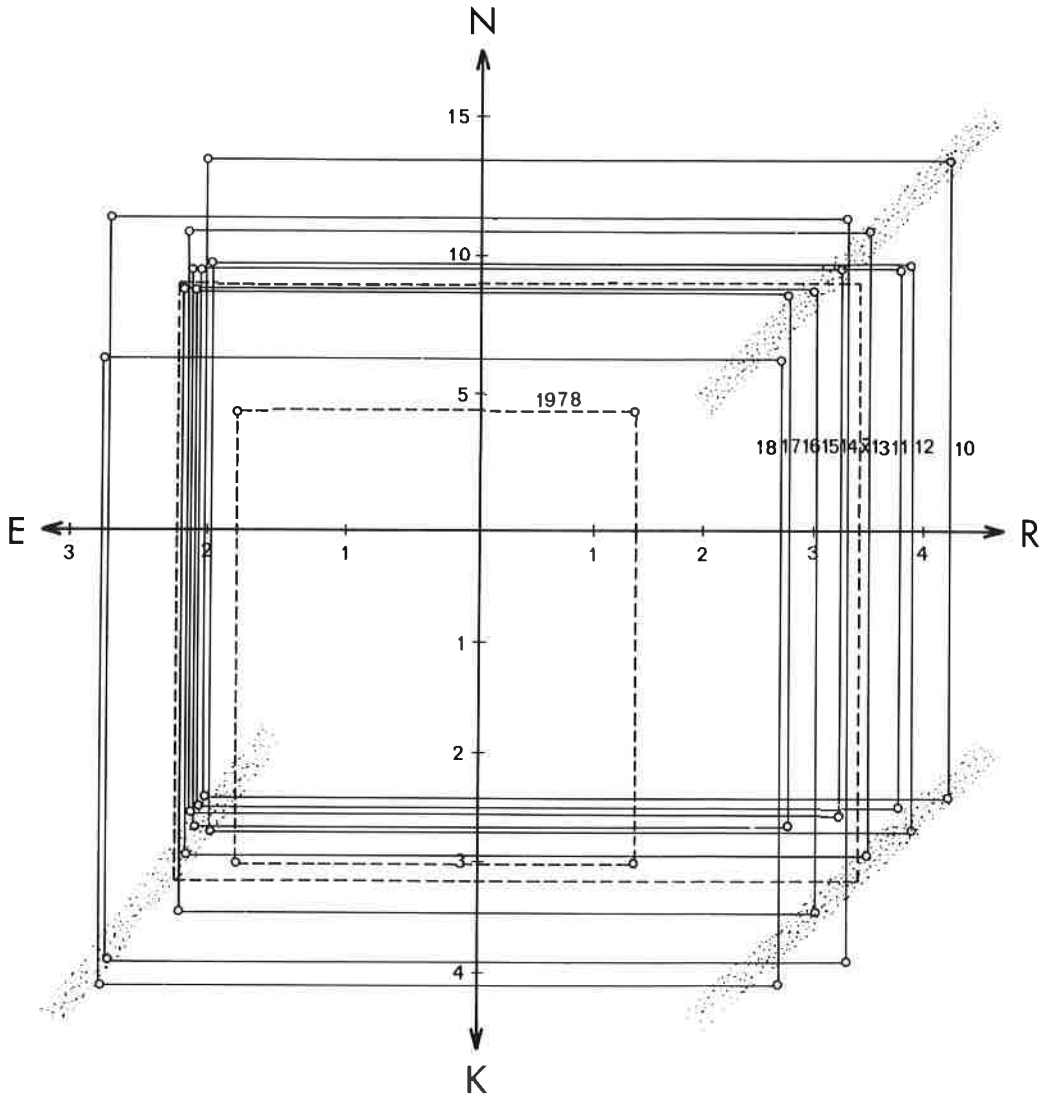

Fig. 25. Employment in resource-independent industries N (1000 persons), net returns R (100 mill. FIM), capital K (1000 mill. FIM) and total output of electricity and heat E (100 mill. FIM) in the alternative economic structure proposed by the group of students. Correlations at $p < .05$ are indicated by the shaded lines. For resource-independent industries, see Fig. 23.

Emphasis within the wood processing industry should in the opinion of the majority of this group of respondents be transferred from pulp manufacture to sawn timber, and only respondent 14 suggested any increase in pulp production over the initial figure, proposing at the same time that a considerable chemicals industry could be developed alongside this. For both groups it is the chemicals industry (SIC 35) that is projected to increase most in employment in relation to

the 1978 figure, just as substantial increases in employment are also proposed in the metalworking sector. Within the student group the greatest such increase, a tripling of employment compared with the initial situation, is put forward by respondent 10. It is only in one reply which strongly favours mechanical wood processing and the clothing industry (respondent 11) that employment in metalworking is projected to decrease from the initial level.

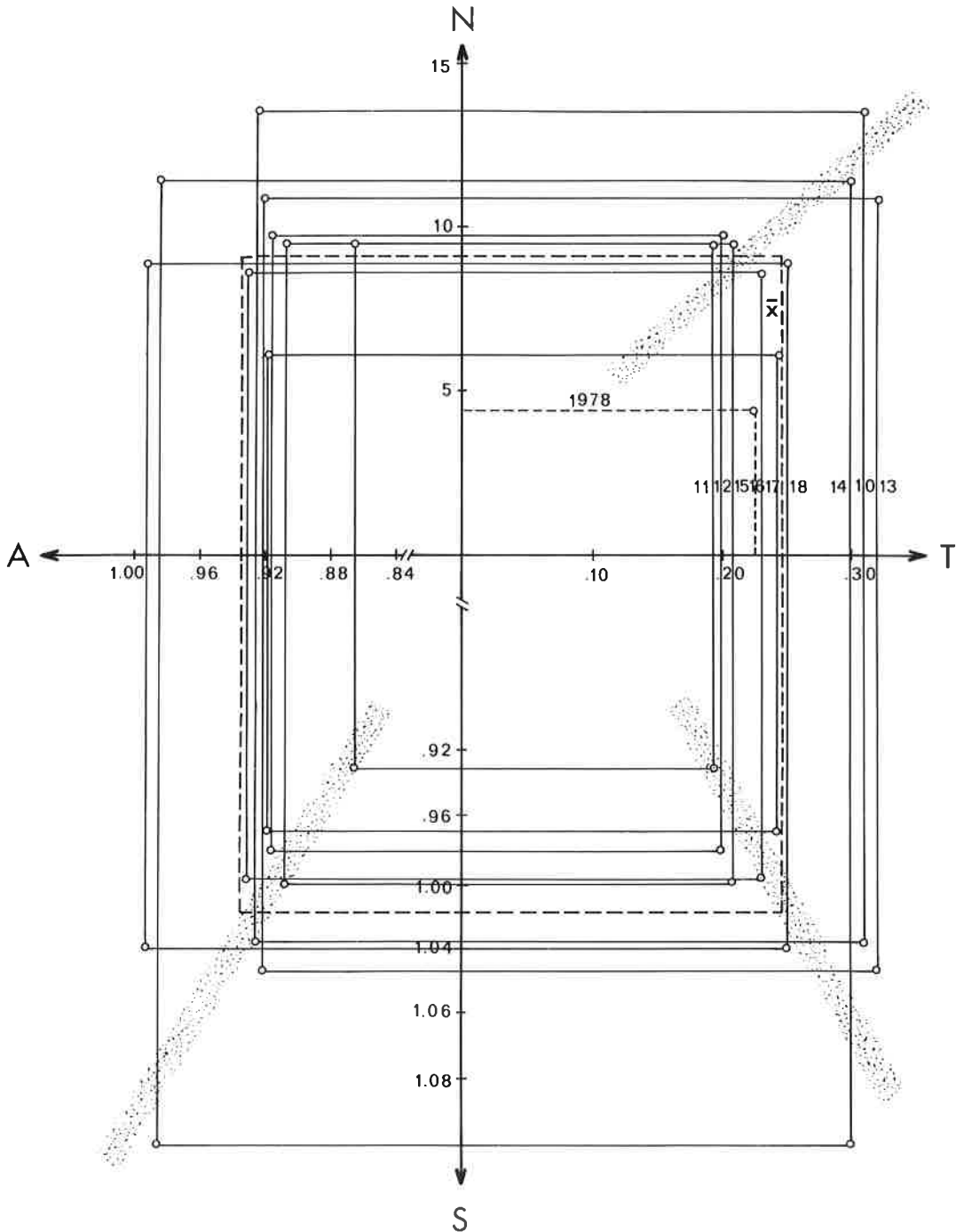

Fig. 26. Structure of employment and wage and salary levels in the alternatives proposed by Group B (students). Correlations at $p < .10$ are indicated by the shaded lines. For key to symbols, see Fig. 24.

The extreme values recorded in Figs. 25 and 26 result from the pronounced influence of specific branches of industry on the overall outcome. The high level of wages and salaries

predicted in reply 14 is attributable to the major increase proposed in the chemicals industry (Fig. 26), and that in reply 18 to the increase in mining and manufacturing industry partially related to this, also leading to a high power input and capital requirement (Fig. 25). In contrast the labour allocations to non-metal furniture, food processing and clothing reduce wage levels below those prevailing in the initial situation (Fig. 26). Relatively little labour is assigned to other manufacturing, which represents a relatively profitable category within the new industries, the highest employment in this field being projected by respondent 12, who also, somewhat exceptionally, assigns a labour force of 500 to the production of metals.

The scatter in the results given by the student group B is in general slightly smaller than that in the Group A results, and the net returns also vary slightly less, between 97% and 207% of the 1978 figure. In fact none of the students is prepared to suggest such radical structural changes as are envisaged by respondents 1 and 2 in Group A (Fig. 25). Correspondingly, the capital and power requirements vary substantially less within the Group B replies, due chiefly to the fact that none of the students planned for any essential expansion in production in the wood processing sector, nor did they allocated labour exclusively to the new industries, which have a low capital requirement. Thus power and heat output in the solutions proposed by Group B varies between +4% and +39% relative to the initial situation and the capital requirement between -19% and +39%. Both wages and salaries remain generally lower in the Group B schemes than in the Group A ones (Figs. 24, 26), so that where salaries increase by an average of 7% for Group A, they do so by only 2% for Group B, while correspondingly Group A would cause the average wage to drop by 4% and Group B by 7%. It is clear that the students tend to favour labour-intensive sectors such as the textiles and clothing industry or the food processing industry, in which wage levels are low (cf. Tables 13, 16 and 17).

The replies given by the student group yielded the same types of dependence relations between the variables as did the Group A replies, even though they are not so obvious. The results of these subjective evaluations point to the lines of development which this economy in transition could follow within the framework of existing technology.

The developmental paradox, infrastructure requirements and income levels

The analysis performed here serves to reveal the *developmental paradox* which haunts peripheral regions. Namely the fact that the more a periphery contents itself with generating the products which its infrastructure and natural resources dictate that it should specialize in, the lower the level of profitability it is obliged to accept. And poor profitability can easily lead to slow growth, as is being experienced now in the resource-based industries.

Poor profitability is especially a problem in capital and power-intensive industries (Figs. 23, 25; Table 12), although it is also true that profitability is the least predictable of all the relations studied here, since rapid changes in demand on world markets can cause quite considerable fluctuations in the profitability of resource-based industries, whereas certain characteristics of these industries such as capital requirements and power consumption, and also their environmental impact, can be altered only very slowly by virtue of technological progress.

The extent of environmental loading in Northern Karelia will depend quite crucially on the way in which the wood processing industries develop, as also will the overall capital requirement in the region, infrastructure needs and the extent of the subsidies put into the area under regional policy provisions. Also, as seen in Fig. 27, the proportion of wood processing in the industrial mix serves to explain in part the gross value of electricity and heat supplies in the different solutions proposed. The dependency of the gross value of water supplies on the wood processing industry is not so marked, since the industry obtains most of its untreated water from pumping stations at the factories themselves, the volumes of water delivered by which are not included in the figures for the water supplies sector. In reality, however, the amounts of water consumed in this industry are so great that water consumption by industry as a factor in the regional economy is quite significantly dependent on the role of wood processing in the regional structure of production (Fig. 15).

Since salaries and wages are higher in the resource-processing industries of Northern Karelia than in the resource-independent ones (Table 13), the increase in salary levels as the economy moves towards a resource-independent structure (Figs. 24, 26) must be due to the use of national levels of technology in the calculations. It is this,

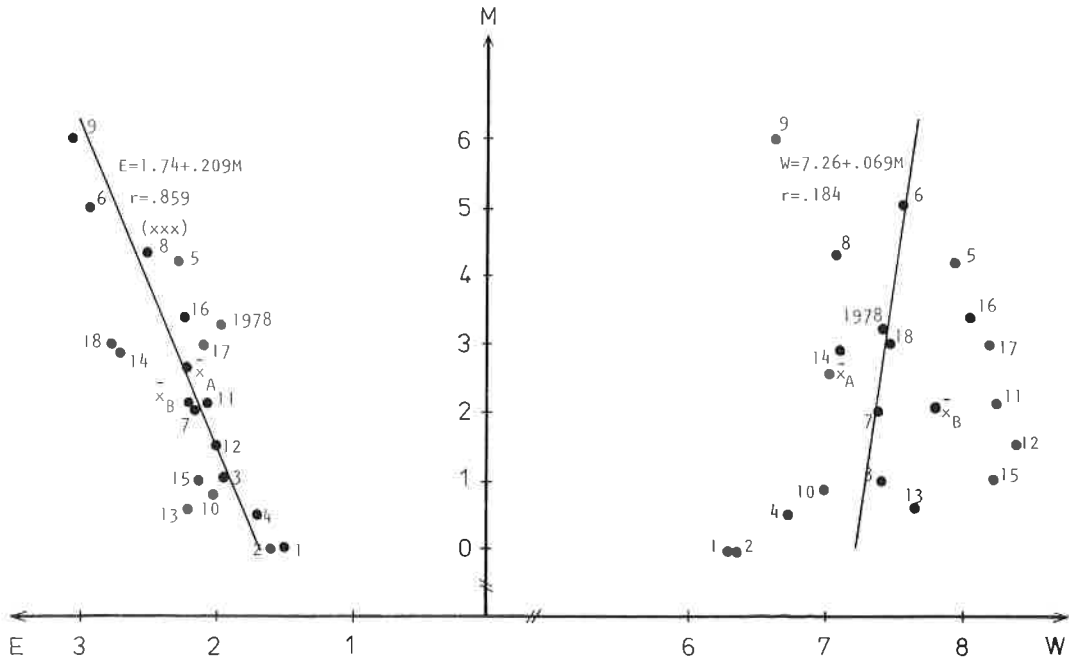

Fig. 27. Employment M (1000 persons) in wood processing (SIC 331 and SIC 341), total output from water supplies W (mill. FIM) and total output from electricity and heat generation E (100 mill. FIM) in the alternatives proposed by Group A (nos. 1—9) and Group B (nos. 10—18).

too, that affects the increase in the proportion of white-collar staff, and also to a statistically significant extent that in salary levels, although admittedly replies 2 and 4 have a substantial influence on these results (Fig. 28). If one was to graft the levels of technology reached on a national scale onto the industrial mix and production figures for the various industries as they were in Northern Karelia in 1978, one would obtain a salary total that was 9.6% higher than the actual figure. On the other hand, levels of technology scarcely have any effect on wages, which would be less than 1% higher than the real figure under the same hypothetical conditions (cf. Fig. 28). The decline in wage levels from the initial situation depicted in Figs. 24 and 26 is to a great extent a consequence of the higher proportion of total production accounted for by the resource-independent industries.

Alternatives I—IV

The crude data provided by the replies of the two groups of informants may be processed by principal component analysis in order to obtain a typology for the structural changes proposed.

The material for this analysis consists of the employment figures put forward by the respondents for the various branches of industry (as denoted by the three-figure SIC codes). No distinction is made in this classification between national and regional levels of technology, so that each data item consists of the sum of the employment figures for the branches of industry carrying the same SIC code on both a national and a regional scale.

The number of factors to be formed was restricted to 4, as factors 5 and 6 proved to have explanatory powers of only 7% and 6% respectively. The principal component solution is obtained by means of Varimax rotation, giving a model with a 74.1% explanation of variance, of which 38.0% is assigned to Factor I, 15.6% to Factor II, 10.5% to Factor III and 10.0% to Factor IV. The typology of alternatives for the economy of Northern Karelia therefore possesses four dimensions, the bases for which lie in the respondents' ideas of what would be suitable branches of industry for the region and the level of production to be aimed at in each. Each parameter contains those variables which carry a weighting in excess of 0.5 on the factor concerned.

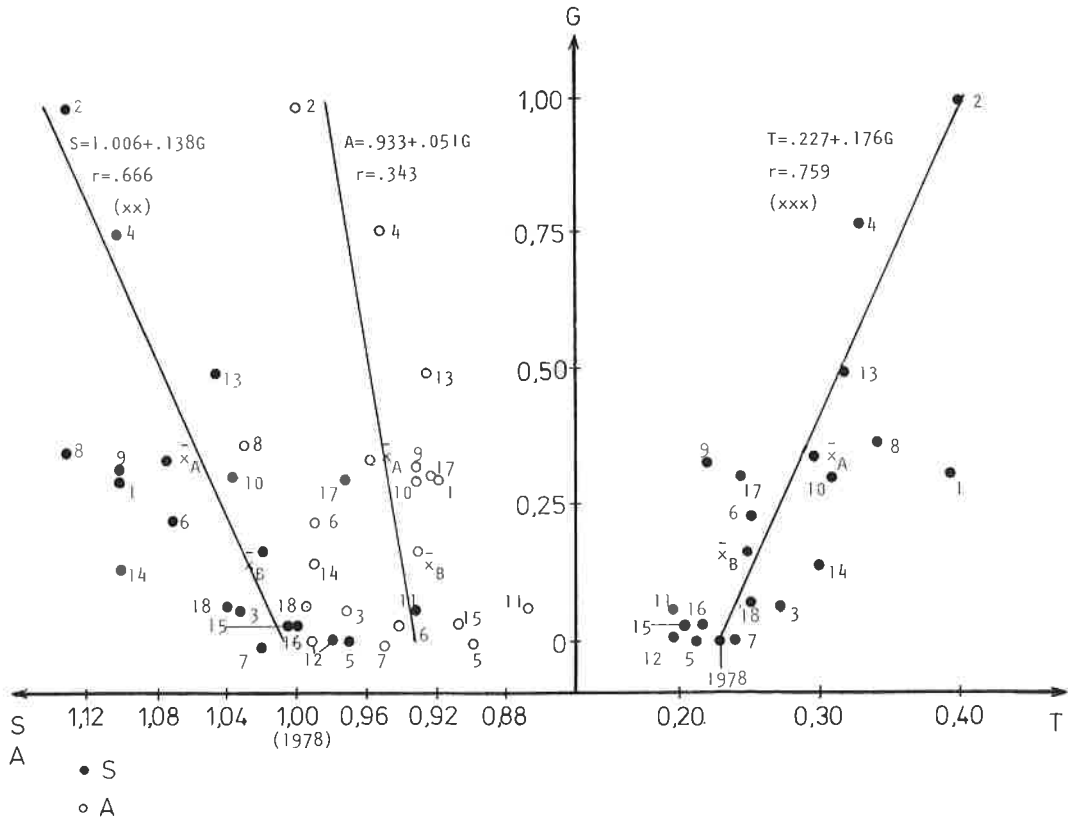

Fig. 28. Effect of proportions of industries in the national economy G (in employment terms) on the structure of employment and salary and wage levels. For key to symbols T, S and A, see Fig. 24.

An actual factor analysis was also performed in conjunction with the principal component analysis, employing as the communalities estimates the highest correlation coefficients lying outside the diagonal. The grouping of the replies obtained using the principal axis, alpha and ULS factor models was the same in each case, and the results proved to be very similar to those of the rotated principal component analysis. The only exceptions were the weighting assigned to respondent 1, which did not exceed 0.5 on any factor, and the exclusion of respondent 7 from Factor II. The image factor model, on the other hand, did give a weighting of over 0.5 to alternative 7, as in the principal component analysis. The parameters given by the principal component analysis may thus be regarded as relatively permanent in character, since an almost identical result is attained with a number of factor models. The principal component solution is therefore chosen for the purposes of the present discussion, as it also includes respondent 1.

The factors indicated by the principal component analysis, composed of replies gaining weightings greater than 0.5, were formed into alternative economic structures by taking the mean employment figures for each branch of industry calculated from the replies falling into the respective groups. The resulting four alternatives were then tested in the simulation model.

The replies were distributed fairly clearly into the four factors, the material containing just 4 instances of replies participating in two factors (Fig. 29). One feature common to all four alternatives is that they allow for an increase in employment in the manufacture of metal products, from +68% to +253% relative to the initial situation, and in the chemicals industry, from +94% to +676%. Increases in these fields could thus be regarded as generally accepted goals for economic structure policy. In other respects the alternatives entail clear, sometimes contradictory differences. Also, the students' replies seemed to fall into a group of their own, since two-thirds

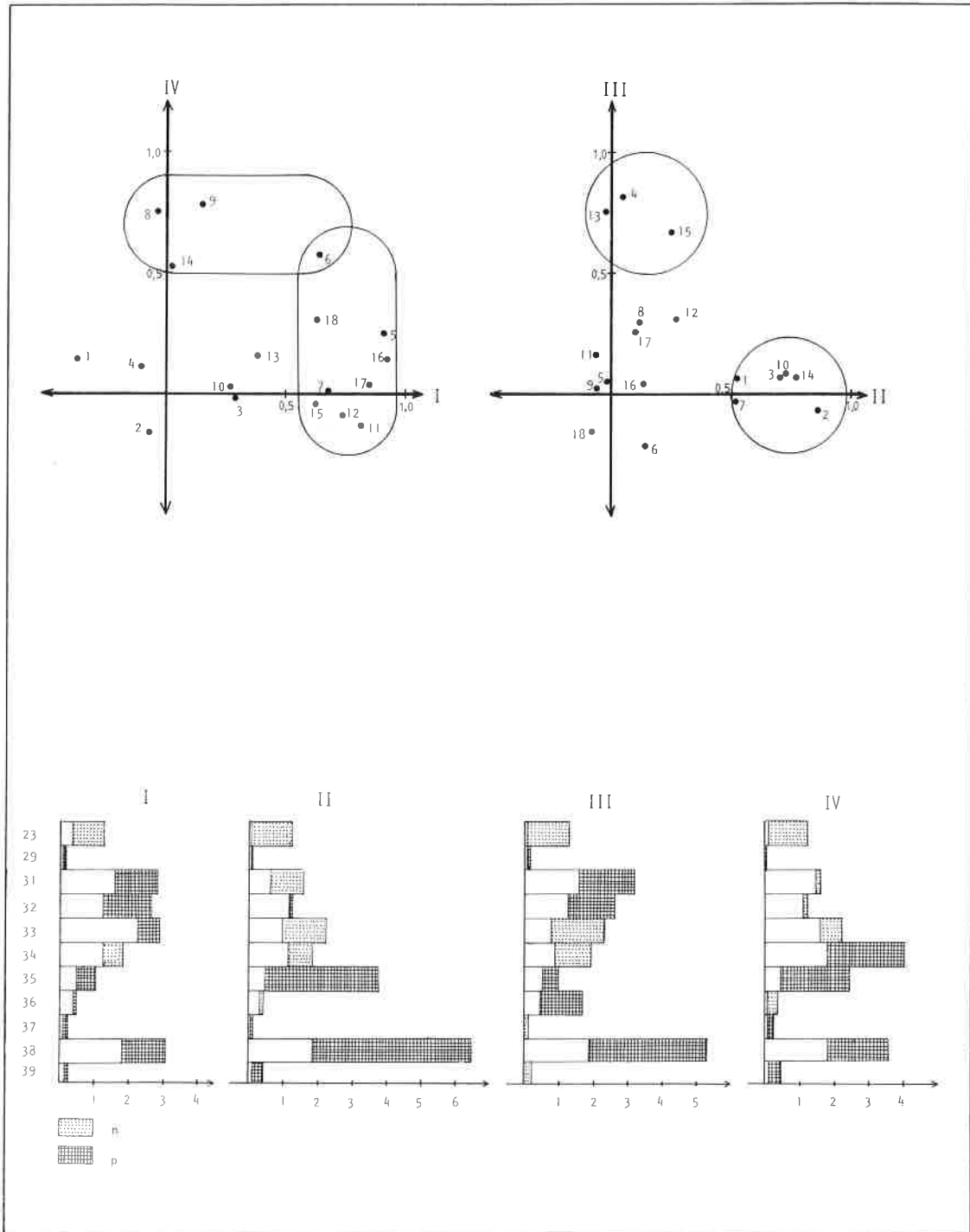

Fig. 29. Grouping of replies into alternatives, and employment by branches of industry (SIC code) under these alternatives. The axes in the upper diagrams denote the factors and the points their loadings in the individual replies, numbered as in the table. Employment (horizontal axis in lower diagrams) is measured in 1000 persons, and the results compared with the situation in the reference year. n = decrease in absolute figures, p = increase in absolute figures.

Table 18. Economic effects of the developmental alternatives for Northern Karelia. * = percentage change from the reference year.

	I	*	II	*	III	*	IV	*
Net returns (mill. FIM)	305	117	369	163	323	131	223	59
Gross value (mill. FIM)	3 245	48	2 574	18	2 993	37	2 180	54
Fixed capital (mill. FIM)	3 264	9	2 661	-11	2 653	-12	4 626	54
Number of personnel	16 118	37	16 012	36	16 025	36	16 295	38
Gross value of power sector (mill. FIM)	229	18	200	3	202	4	281	45
Gross value of water supply (mill. FIM)	7.9	7	6.9	-7	7.5	2	7.1	-4
Number of establishments	474	134	681	236	551	171	474	133
Number of salaried persons	2 876	30	2 607	63	3 456	57	3 445	56
Number of wage-earners	12 888	36	11 572	22	12 069	27	12 416	31
Sum of salaries (mill. FIM)	123	31	164	75	155	65	161	71
Sum of wages (mill. FIM)	278	26	349	17	353	18	384	28
Average salary (FIM/year)	42 671	0.2	45 633	7.2	44 934	5.5	46 715	9.7
Average wage (FIM/year)	29 359	-7	30 179	-4	29 258	-7	30 965	-2

Composition of labour force, percentages:

					1978
Salaried persons	18		24		19
Wage-earners	82		76		81

of them are to be found under Alternative I.

Alternative I may be referred to as the *reorganization alternative*. The extent of a change in structure may be measured in terms of the numbers of employees required to move from one industry to another. If $q(i)$ is the number of employees in industry i in the alternative in question and $q^{78}(i)$ the number in that industry in 1978 (see equations 24), then

$$(31) \quad \alpha = \frac{\sum |q(i) - q^{78}(i)|}{\sum q^{78}(i)}$$

The change in economic structure measured in this way, as the sum of the changes in employment in the various industries relative to employment in 1978, is smallest in this alternative ($\alpha = .63$), and the changes proposed increase profitability more than they do employment (Table 18). The focus of growth in production lies in metalworking, textiles and clothing, the processing of foodstuffs, sawn timber and the chemicals industry, while employment in the mining of ores and manufacture of wood pulp is below the 1978 level. This alternative subsumed 50% of all the replies and is in that sense the dominant line of development to emerge from this section of the research.

The increase in production presupposed under this schema is located in industries which are less capital-intensive than in 1978, and the increase

in capital required is only 9% over the level in that year. The changes in labour structure are small, the ratio of salaried to wage-earners being practically the same as in 1978, as also are salary levels, although a drop occurs in wage levels.

The reorganization alternative devotes more of its total employment to the resource-processing industries than does any other alternative, and the largely backward multiplier effects are more clearly concentrated on primary production, and thereby on the spatial structure of the sparsely populated areas.

It is often required that growth in a regional economy should stem from an impulse provided by external demand, and this principle is also reflected in the answers. Examples of this are the proposals to increase production in the textiles and clothing sector and in metal products, which is in accordance with the industrial and regional policy prevalent in the 1970's, and much industry did indeed grow up in the region during that period (Table 1). One advantage for the location of footloose industries of this kind in the area is the fairly large reserve of labour available and the regional policy subsidies to which operators are entitled.

One feature which goes against local industrialization policy, however, is the reduction in

pulp production. The respondents are of the opinion that the chemical pulp industry should not be expanded in spite of the good supplies of raw materials, nor do they regard it as probable that production of paper and other more advanced manufactures in the wood processing industry could be increased. One factor influencing this could well be the lively discussions held on this topic in the late 1970's, in which the industry was of the opinion that it was not feasible to contemplate major investments in pulp and paper manufacturing in Northern Karelia (see also Jaakko Pöyry . . . 1981). A preferable course was held to be the expansion of such industries in areas close to their markets (see Seppälä et al. 1980: 98). More recently, discussions have been resumed on the rebuilding of the pulp mill at Eno, and it has been proposed that its capacity should be doubled.

Alternative II could be regarded as the *metal and chemical products alternative*. A cut-back in production is envisaged throughout the resource-based sector with the exception of clay and stone products, and the net returns are the highest of all the alternatives, +163% relative to the initial level. This alternative is economical as far as both capital and power input requirements are concerned, but the structure of the labour force would alter markedly, with over 1.5 times the number of salaried employees compared with the 1978 situation.

The most significant increase in employment is in the chemicals industry (+676%), a branch which is seen as comprising mostly light industries manufacturing other chemical products and rubber and plastic goods (which would account for 89% of employment in this sector). The heavy chemical industry, involving largely industrial chemicals, would be responsible for 11% of production in this overall sector (SIC 35). No essential bonds exist between the chemicals industry and resource-based functions in the region, largely wood processing.

The metal and chemical products alternatives is grounded predominantly in the newer industries, which it is hoped to attract partly by means of regional policy subsidies. The aim is to develop the economy chiefly in those fields in which pronounced economic growth is to be expected on a national scale (cf. Kässi 1982: 21). Little use is made of local resources, and as the food processing industry is assumed to decline in importance, a considerable reduction in agricultural output would seem, inevitable. This alternative divorces development almost entirely from other

aspects of the structure of the regional economy, i.e. links with primary production or with the infrastructure of a predominantly primary sector-oriented region. Development of the economy in this direction would presuppose changes in the occupational structure and would impinge on the spatial structure itself. This alternative implies large movements of labour between industries, so that $\alpha = 1.05$.

The third alternative, the *textiles, clothing and metal products alternative*, comprises those replies which laid emphasis on increases in these fields together with the food processing industry, whereas employment in local resource processing, sawn timber and pulp manufacture would decrease. The reduction in roundwood processing would be offset by a 306% increase in the manufacture of clay and stone products, i.e. intensified use of non-renewable natural resources.

Employment in the metalworking industry is projected to increase from just under 2000 in 1978 to over 5000, the main emphasis being on the manufacture of electrical goods (54% of total employment in the sector), whereas the emphasis under alternative II was on instrumentation (38%).

Alternative III generates high net returns, +131% compared with the reference level, and entails the lowest capital requirement of all the alternatives considered, -12% relative to the 1978 situation. The labour force is dominated by salaried staff, income levels remaining low. Wages in the textiles and clothing sector in particular fall below the mean industrial level.

This alternative has a higher employment in the food processing sector than any other schema discussed here, involving a shift to longer chains of processing within the industry, with 21% of its production based on national-level technology (SIC 311-2). Also, part of its production is expected to consist of beverages, accounting for 8% of employment in the sector. Shifts of labour between industries will be frequent ($\alpha = 1.07$), but not as dramatic as in the profitability-based alternative generated by the LP model ($\alpha = 2.10$).

The fourth alternative, the *wood processing and chemicals alternative*, presupposes a doubling in pulp production and a quadrupling of the chemicals industry. The latter is conceived of as being partly linked with wood processing, with the production of industrial chemicals occupying 38% of its labour force. The largest single branch of the chemicals industry would neverthe-

less be plastics, employing 40% of the labour input into this sector. The mobility of labour required under this alternative in relation to the initial situation is lower ($\alpha = .75$) than in alternatives II and III, and lower than in the resource-processing alternative generated by the LP model ($\alpha = 1.06$).

The net returns under this alternative are lower than with the others considered here, but still a considerable improvement on the initial level. Profitability in the wood processing sector would be stimulated and the degree of processing increased by locating 2/3 of those employed in pulp manufacture of production lines requiring national-level technology. The capital requirement and power consumption would increase by half again compared with the reference level, which would place heavy demands upon the infrastructure, and both salaries and wages would be higher than with the other alternatives. The economy would become markedly more dominated by salaried staff, partly due to the prominent role played by the chemicals industry, and to a great extent in response to the more advanced technology to be adopted in the wood processing sector.

This alternative concentrates very heavily on exploitation of the region's timber resources and the development of a chemicals industry on the strength of this, but both food processing and sawn timber production are expected to decline. As far as the chemical pulp industry is concerned, this solution works very much along the lines proposed at the provincial level in the late 1970's, according to which the roundwood extracted from the forests of Northern Karelia should be processed within the region itself (Pohjois-Karjalan . . . 1978). The present alternative falls short of this target as far as sawn timber is concerned, as the level of production allowed for would not suffice to consume all the sawlogs available locally, but exceeds the provisions of the existing permitted cut for cordwood by 10%, so that pulp production on the scale envisaged here would involve either the importation of timber or changes in processing techniques.

Comparison of the alternatives

If we now consider together the counterfactual alternatives A and B and the alternatives I—IV generated by factor analysis of the subjective evaluations, we find that in all of these profitability increases more relative to the reference level than does employment, reflecting the *opportu-*

nities for rationalization existing within the production structure. The profitability-based alternative A created by linear programming produces very much higher net returns than any of the others, with a capital requirement that is at the initial level and a saving of a couple of percent in electricity and heat consumption. Its highly one-sided structure nevertheless makes it no more than a fictive calculation. The resource-processing alternative B also produces higher net returns than any of the four alternatives compiled from the subjective suggestions, and double that achieved in subjective alternative IV, that which comes closest to it in structure, with its emphasis on wood processing and chemicals. Alternative B nevertheless only gives about half the net returns obtained with the maximum profitability alternative A, and requires double the input of capital and power. Optimization in the direction of either profitability or full exploitation of the region's natural resources may thus be seen to yield substantially higher profitability values than the subjective evaluations.

The starting point for the majority of the subjective evaluations was evidently the preservation and further development of at least parts of the existing economic structure, the exceptions being respondents 1 and 2. The tendency is then to cut back on production in less profitable industries rather than closing them down entirely. The principles for allocating production vary greatly, but the outcome is usually a diversification of the economy. Profitability figures do not match up to those achieved by optimization, and this in a sense serves to point out the problems associated with definition of the goals of economic development. The alternatives contain evidence of goals which take the form of maintaining the infrastructure, taking account of the nature of the labour force, preserving the quality of the environment, processing the region's own natural resources, diversification of production and the formation of processing chains, and these criteria are frequently of greater importance than is profitability, since few of the replies appear to select their combinations of industries and levels of production exclusively on the grounds of profitability. The group of students in particular were well aware of the multiplier effects likely to be brought about by any changes in the structure of production, including the effects on profitability.

A dichotomy may be observed in the attitudes of the respondents towards the development of the wood processing industry. Either pulp pro-

duction should be substantially reduced or else the branch should be developed by changes in technology and establishing links with the chemicals industry. The conditions which argue for development of this industry are seen to include the good raw materials base and to some extent perhaps the local infrastructure and the opportunities for exploiting external advantages.

Important areas for expansion, in the opinion of the respondents, would seem to be metal products and chemicals. Good arguments for growth in the new industries are to be found mainly in the large reserves of labour in Northern Karelia and the advantages offered under regional policy legislation. Much has already been done to develop communications (roads, railways and telecommunications), and local authority policies have led to the building of industrial premises and the arranging of finance. These are precisely the infrastructure factors which are regarded by many as crucial for the location of industry (cf. Eriksson & Toiviainen 1978; Koski 1979) and serve especially to promote the expansion of those new industries.

The relatively high employment in the food processing industry allowed for under alternatives I and III is derived from the changes thought to be taking place in the demand for foodstuffs and the new opportunities which exist for specialization. The students certainly thought it quite possible to increase production in this field by means of specialization. Situated as it is on the fringe of the densely populated parts of Europe, Northern Karelia can make much of the relatively pollution-free conditions under which it raises its agricultural special products. This is in good agreement with the notion of specialization in agriculture as a function of physical conditions and accessibility (see Butler 1980: 65—67). The other subjective alternatives, II and IV, involve a decline in employment in the food processing industry in relation to both the present situation and the reference level used here.

Optimization, subjective evaluation and the economy of Northern Karelia

The results show that the economy of Northern Karelia as it is at present is not operating at an especially high level of profitability as compared with what it could achieve under the conditions assumed by the evaluation models. A change in the direction of a more profitable structure of production implies reorganization, the

elimination of unprofitable functions and the redirection of the productive effort. This is to some extent what has been done in the years following the basal year chosen for these calculations, 1978. Employment in the mining of ores has declined (as the mines have become exhausted) and a peat brickette factory which was running at a loss has been closed, major reorganizations have taken place in the wood pulp industry, and some attempt has been made to improve its profitability by means of government transport subsidies.

The results obtained by linear programming and subjective evaluation suggest that the more the economy inclines towards the resource-independent type of industry, the higher its mean profitability will rise. Similarly capital, power and water requirements will increase more slowly the greater is the proportion of new industries in the economy. The profitability estimates used here are valid for the years 1974—79, during which the economy went through a serious depression and the power-intensive industries suffered from the problems engendered by the oil crisis. Thus variations in profitability are bound up with the intensity of power utilization and the extent of capital investment.

The below-average wage levels typical of many peripheral areas are not found here, even though differences do exist in individual industries, but the level of salaries is below that for the country as a whole, reflecting a certain degree of areal differentiation between operative and central office functions, a fact which often has to be taken into account when considering regional development (Goddard 1978: 62—70). The results yielded by the model show that development of the economy may lead to a lowering in wage levels, the only exception being found here in the case of the linear programming alternative based on full exploitation of natural resources, whereas future salary levels are likely to be influenced not only by the industrial mix as such, but also by what happens in the intra-firm spatial division of labour.

The economy of Northern Karelia contained three branches of industry that could be said to have gone through crises of their own in the wake of the first oil crisis, agriculture, pulp manufacture and mining. The respondents' attitudes towards the first of these can be assessed here only indirectly through the changes in employment advocated in the food processing sector. Here sharp differences appear between the proposals. The crisis in the resource-based sphere

is reflected in low profitability in these sectors and in the alternatives which entail large volumes of resource-based production. The full resource utilization alternative nevertheless gives a fairly high profitability figure, even though this is partly achieved as a result of the presence of certain branches of the new industries in its mix. It is undeniably the case, however, that development of the resource-based industries would entail a substantial increase in capital input and power requirement.

Short-term changes in the distribution of employment in Northern Karelia can necessarily give only cautious indications of future developments, as they may contain in them evidence of temporary deviations from the main trends, in the form of individual investment decisions, closures of factories or fluctuations in economic conditions. The changes in employment which actually took place over the period 1978–83 are nevertheless the following (two-figure SIC codes, mean percentage changes per year, SVT XVIII A: 99, 104):

(2) Mining and quarrying	−3.3
(31) Food processing	−2.0
(32) Clothing etc.	1.2
(33) Wood processing	3.3
(34) Pulp and paper	.3
(35) Chemicals	7.3
(36) Non-metallic minerals	5.4
(37) Basic metal industries	closed down
(38) Machinery etc.	7.0
(39) Other manufacturing	−4.0
(4) Electricity and water	.1

Viewed in terms of this two-figure SIC classification, the new industries, SIC 32, 35, 37, 38 and 39, showed an increase in employment of 4.6% per year over the period 1978–83, compared with 0.5% per year in the resource processing industries (1.3% per year if mining is excluded). This implies that over the whole period 1970–83 the numbers employed in the new industries will have increased by a factor of 5 while those in the resource-based sectors rose by only 12% (SVT XVIII A: 92, 104). Thus growth over the five years following the year used as a basis for the present calculations, 1978–83, has clearly taken place in accordance with the alternatives that stress the role of the new industries (alternatives II and III and the profitability-based alternative, see also section 'Fictive growth ...').

The economic transition naturally affects the content of core-periphery relations (section 'Core-periphery relations ...'), even though

such changes generally become significant only after a long interval in time. Northern Karelia has been a hinterland for centuries, an area whose economy has been based chiefly on the exploitation of natural resources, largely on exports of agricultural products, ores, timber, etc. for consumption and further processing elsewhere. The transition of the 1960's and 1970's meant in effect that these amounts of natural resources or their products increased somewhat, but the new industries still made little impact on the use of either raw materials or power in the region. Instead, any changes which took place in the use of natural resources were dictated primarily by the industries based on these local raw materials. Similarly many major investments, in machinery, power stations, etc. were chiefly linked with the promotion of resource processing. It would need quite drastic changes in the economy before the fundamental form of the core-periphery model were to alter at all as far as the utilization of materials derived from the periphery is concerned.

It is clear that the features typical of a resource periphery, e.g. predominance of primary production, predominance of raw materials among exports, or predominance of resource processing among employment opportunities, are beginning to decline. The new industries have become to an increasing extent significant factors in the development of the periphery. But this dispersion of industry into the periphery has not solved its developmental problems. Unemployment remains high, and the spin-off effects of the new industries frequently bring problems of their own (e.g. in the spatial division of labour and the closure of factories in certain branches). This situation presents the resource periphery with a new challenge. How can one find new outlets for exploiting the region's natural resources, how can one promote the new industries, and how should one react to the spatial division of labour?

Use of natural resources and development of the peripheral economy

Significance of resource-based industry

We shall take a look in this chapter at the characteristic features of development in a resource periphery, i.e. how a dynamic aspect can be added to the core-periphery model (section

''Core-periphery relations ...'') and in what direction its principal elements, the division of labour, materials flows, etc. have been developing and may develop in the future. These paths of development which extend from the transition in economic structure into the prospects which begin to emerge for the future are united by the developmental mechanisms that prevail in the periphery, e.g. multiplier effects, spatial division of labour, etc., all of which are likely to gain different manifestations as development proceeds.

The core-periphery relations depicted in the model (section ''Core-periphery relations ...'') are to a greater or lesser extent dependent on the rate of change prevailing in the various elements of economic development, and new transient or permanent features tend to emerge as a result of development, e.g. the developmental paradox cited above. All these aspects serve to describe and explain the process of regional development and form part of the model of core-periphery relations.

Northern Karelia represents an area of resource-based industry in which the problems facing such industries and the development mechanisms typical of them become generalized to affect the development of the whole region. This structural feature gains in emphasis as we set out to study development in Northern Karelia in the light of general theories of regional development.

The transition of the 1960's and 1970's

The dominant mechanism: rationalization and the labour supply effect

The fact that utilization of natural resources in Northern Karelia increased in spite of the upheaval in the occupational structure suggests that the sharp reduction in the labour force in the primary sector meant above all a process of *rationalization*. This together with the general increase in the working-age population created circumstances which led to unbalanced development. The *labour supply* grew markedly in the 1960's, at the same time as productivity in agriculture and forestry improved rapidly by dint of technical and organizational reforms, also increasing the supply of labour. Since the amount of labour engaged in agriculture in the early 1960's was high compared with that in industry, quite small percentage changes were able to give rise in relative terms to extremely great pressures

for growth in industry and the service sector. And although the labour input to these spheres did indeed increase markedly, nothing could be done to regulate this structural change as far as the balance between supply and demand on the labour market was concerned. The resulting imbalance led to pronounced out-migration in the late 1960's and early 1970's. In this respect it may be said that out-migration and unemployment, the inevitable consequences of the basic market mechanisms, were aggravated by the high proportion of the economically active population engaged in primary production and the speed with which the structural change was carried through.

Economic development in Northern Karelia was influenced to a critical extent by the modernization of the structure of production and the release of the pent-up population pressure. A trend of the same kind was also observable elsewhere in Finland, but not at the same speed, for here in the development regions the sharp cut-back in labour in agriculture and forestry in the 1960's came only a few years after the programme of resettlement in the countryside which had had the effect of substantially increasing agricultural production. It was only as a result of developments during the 1960's that the proportion of the economically active population engaged in agriculture and forestry fell below 50%. This was a much later date than elsewhere in Finland, as this proportion was only 34% in Uusimaa even in 1910 and fell below 50% elsewhere in the industrialized part of the country immediately after the Second World War (Niinisalo 1974: 58—59, 225). By the early 1960's the corresponding proportions were about one third in the industrial region of the country as a whole and no more than 9% in Uusimaa. It is also true that the change in occupational structure created more than usually difficult problems on the labour market in the development regions, where primary production was of considerable significance as a source of employment.

The sudden rationalization of primary production has been assigned relatively little attention in theories of regional development, even though these have been used to study development in highly agriculturally dominated areas. Examples of such theories would include the regional growth theories, which concentrate on the advantages of agglomeration, innovations and trickling-down effects (see Richardson 1977; Hermansen 1972). A resource periphery has very little advanced industry taking place in an urban environ-

ment, or perhaps none at all, and thus any changes in the utilization and processing of resources will have affects which will dominate the whole economy.

Neo-industrialization: dispersal and diversification

Northern Karelia did have in effect a significant amount of industry at Outokumpu, Eno, Joensuu and Lieksa at the beginning of the transition in occupational structure, and development in the 1970's served to increase the number of jobs in industries in the southern parts of the province, notably the communes of Kitee and Kesälahti (Fig. 30), where the infrastructure had improved considerably with the building of a railway, the national highway no. 6 and a deep-water channel for shipping.

As a general rule, industrial growth may be said to have been most rapid in percentage terms in the rural areas and least so in those that were already industrialized. Another area of marked growth comprises the environs of Joensuu itself, and in general it is the case that the new industries, which have been responsible for the majority of this expansion, have been freer in their locational constraints than the traditional resource-processing branches. Northern Karelia underwent two periods of rapid growth in the 1970's, from 1972 to 1974 and from 1978 to 1980 (Fig. 30). These were both periods of expansion for the economy of the whole country, and industrialization in Northern Karelia was able to follow these trends well. At the same time it seems that industrialization in the development regions and rural areas of Finland has obeyed the general *dispersive trend* predominant in countries with a market economy, even though the increase in the industrial labour force has occurred somewhat later in time than in many other western countries (cf. Tykkyläinen 1987a, Keeble 1980).

Although the regional capital, Joensuu, has grown in terms of population, level of services and educational opportunities, this does not lend much support to the traditional notion of growth via urban development expounded by Friedmann (1966, 1973). The administration of companies at the national metropolis level directs jobs to the periphery, but without any main office or other functions to bind them to the regional capital level or to any other urban environment in the periphery itself. Location is dictated by integration into the national economy and by profit and cost factors, including the availability of region-

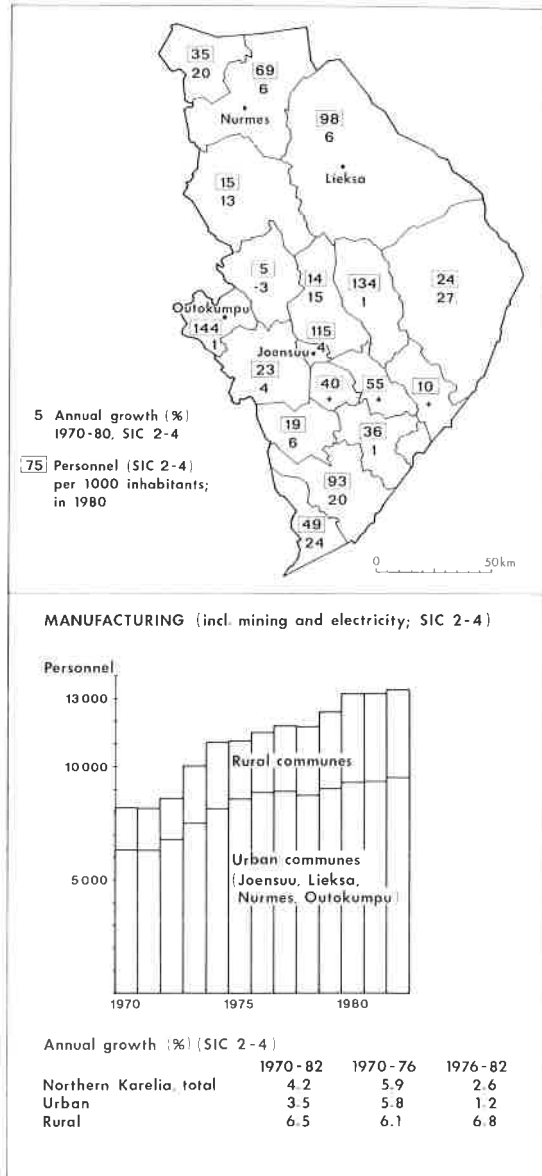

Fig. 30. Growth in industry (SIC 2—4) in Northern Karelia over the period 1970—1982 (SVT XVIII A).

al policy subsidies. The location of industry in Northern Karelia is indeed explicable in terms of general spatial cost factors (Smith 1981), and local trickling-down effects are very limited, as also are leading propulsive firm explanations based on growth pole theory. The fact that some growth is to be seen around the major centres (see Tykkyläinen 1987a) is mostly a result of the fact that the urban environment is too expensive for floor-level functions.

Table 19. Annual growth in employment in given branches of industry in Southern Finland and the development region in 1970—78. SIC code, growth in the development regions and growth in Southern Finland are indicated in parentheses.

		Southern Finland	
		Growing industries	Declining industries
Development regions	Growing industries	Petr. prod. (354; ∞, .7) Instruments (385; 35.7, 4.3) Non-ferrous (372; 11.6, .1) Electrical (383; 9.3, 2.0) Iron (371; 9.6, 1.2) Ind chem. (351; 2.9, 5.4) Petroleum ref (353; 0, 6.6) Other chem. (352; 2.0, 2.0) Fabr. metal (381; 3.9, .3) Printing (342; 2.7, 1.2) Machinery (382; 3.3, .2) Paper (341; 1.6, .3) Transport eq. (384; .3, 1.6)	Rubber (355; ∞, -1.5) Pottery (361; ∞, -7.6) Glass (362; 6.3, -2.7) Furniture (332; 5.5, -.2) Minerals (369; 4.0, -.2) Wearing (322; 3.8, -1.7) Footwear (324; 3.6, -3.6) Textiles (321; 2.1, -4.5) Food (311—2; 1.3, -.2)
	Declining industries	Other manuf. (390; -1.2, .4)	Plastics (356; -.33, -.8) Beverages (313; -.8, -.9) Tobacco (314; -1.1, -.6) Wood (331; -.9, -1.4) Leather (323; -2.9, -3.1)

Organizational and technological deviations and selective growth

The invasion of Northern Karelia by new industries has diversified the structure of the regional economy and created a new industrial infrastructure, but this diversification has taken place in a selective manner. Industry in the region has the highest wage-earners/staff ratio of any in the country, and the trend has become more accentuated over the period 1960—80 (Eskelinen 1984: 23). The proportion of professional engineers in the region is low (Malinen 1985: 10), and little research and development work takes place. The majority of the industrial functions are pure implementation work. Sectoral, intra-sectoral and intra-firm deviations of this kind from the mean distribution of functions on a national scale may be collectively referred to as the *organizational deviation in labour*.

Selective growth may also exist at the level of specific branches of industry. Growth in the development regions of Zone I, which includes Northern Karelia, in 1970—74, is said to have taken place in branches which were undergoing a recession in the Finnish economy as a whole (Lehmusto 1980: 37). Data on employment in industry (SIC 3) in Southern Finland (provinces of

Uusimaa, Turku and Pori, Häme and Kymi) and the development regions (the remaining provinces) over the period 1970—78 are presented in Table 19. Growth figures for the various branches show a positive correlation both in Southern Finland and in the development regions ($r = .3233$, $n = 25$, $p = .057$) once branches 354, 355 and 361 are excluded, and this correlation continues to be positive even when branch 385 is removed. Since this correlation is not an especially close one, however, it may be concluded that spatial differences in growth processes do exist. Such a positive correlation nevertheless serves to emphasize the main direction of development, namely for industrial growth and recession in the development regions to occur for the most part in the same branches as in Southern Finland.

The occurrence of some growth in the industries of the development regions in sectors undergoing recession in Southern Finland is a symptom of the opportunities for expansion offered by such regions, especially in fields which are not too demanding technologically. The industries involved are in fact typical ones with a high labour requirement (Table 19). Similarly the fact that the ratio of increase in labour force to increase in production is higher in the develop-

ment regions than in Southern Finland (Okko 1985) points to the location of technologically more labour-intensive industries in the region. Since there are also differences in profitability between the economy of Northern Karelia and that of the country as a whole in many respects, one can also speak of the existence of a *technological deviation*. These organizational and technological deviations are of a direction which suggests that they will not create the conditions needed for expansion in the resource periphery.

The rapid industrial expansion that took place in Northern Karelia and on a more general scale entailed for the most part the creation of new factories in the development regions or branches related to existing companies, whereas actual moves by whole firms from the south of Finland to this development region were few in number, especially by comparison with the numbers present in the potential source areas. Thus the number of jobs transferred from Southern Finland to the development regions in 1970–74 corresponded to 1.4% of total employment in industry in the former area in 1970 (Lehmusto 1980: 65). Similarly, Lehmusto (1980: 67) claims that 12% of the new employment opportunities created in the development regions in 1970–75 had been moved there directly from Southern Finland. As the labour shortage in Southern Finland around the mid-1970's gave way to increasing unemployment, the shifting of industrial jobs in this way slowed down.

These features of the spatial division of labour and technological properties point to *selective growth* in industrial functions, in which use is made of regional policy advantages and that part of the labour supply which is suited to industrial work. These developmental features lend support to the product cycle theory in which an industry that has achieved a certain level of maturity can be moved to the periphery (Erickson & Leinbach 1979). It is difficult, on the other hand, to detect any industrial growth based on the advantages of aspatial agglomeration as predicted by the growth pole theories. The only evidence for such trends is to be found in certain resource-processing sectors, e.g. wood processing.

Dominance effects of recessive and stagnant sectors

Classical sector theory emphasizes the importance of income elasticity in relation to demand (Perloff et al. 1960), and this is also of importance for development in a resource periphery,

since the direct and indirect products of resource-based sectors include many which have a low income elasticity in countries with an advanced market economy. When demand offers few opportunities for expansion, productivity is on the increase and the supply of natural raw materials is finite, these sectors can easily experience recession or stagnation. And when the whole structure of the economy relies heavily on such resource-based industries, these *recessive* and *stagnant* sectors tend to *dominate* the development of the regional economy.

Only a slow increase in the labour force in the wood processing industries has taken place in Northern Karelia since 1970, employment in the food industry has not increased at all since that time, and employment in mining has declined markedly, especially in recent years. The problems experienced by such resource-based industries are most in evidence in communes which rely on one establishment of this kind, e.g. Eno with its wood processing or Outokumpu with mining. These are areas where slow growth in the demand for labour, and in places even a reduction in demand, has led to a regional development pattern of the downward-transitional type in these sectors.

The term 'staple trap' has been used to describe the diversification problems experienced by areas which are reliant on a single industrial sector (Raumolin 1982). When a peripheral economy falls into this situation, it is usually because it possesses large industries of a resource-processing kind in which growth has come to a standstill, together with some very small companies of other kinds which are of negligible significance precisely because of their small size and also because no substantial linkages between operators in the new industries are likely to arise in small peripheral areas. This means that a recessive or stagnant situation as measured in terms of employment in the resource processing sectors can, through its multiplier effects, come to dominate the development of the whole peripheral region.

Exploitation of the environment

Principal attention in the theoretical part of this work was devoted to the opportunities for exploitation offered by natural resources, and it was shown that 1) a resource periphery is an area which is exploited in an *extensive* manner. Spatial specialization, in Finland at least, has not meant the confinement of predominantly primary production functions exclusively to the periph-

eries, and thus the core-periphery model cannot be based entirely on the idea of spatial specialization, i.e. the simple notion of a sectoral division of labour between developed and underdeveloped regions. Exchange takes place at very many levels on a spatial dimension as well, and natural resources end up by being fed into a network of core-periphery areas at the national and international levels, including in particular foreign exports.

Economic transition in a periphery also seems to imply 2) an *irreversible break with the natural resource base*, i.e. employment and income problems in Northern Karelia, a peripheral region in terms of modern technology and price levels, cannot be solved simply by increasing exploitation of the natural resources and an increase in the chain of conventional processing. All the same, the resource processing stratum in the economy is bound to remain, and the act of breaking free from it cannot concern more than one part, albeit the larger part, of growth in the periphery. Another feature which the present work was able to draw attention to was the change in environmental loading associated with economic transition, in the sense that this structural change would imply 3) a *reduction in the intensity of loading* from the regional economy as a whole. Thus as industry advances it should be possible for the periphery to avoid any linear increase in environmental loading in relation to production.

The economy of Northern Karelia would seem to have reached a kind of saturation point as far as the exploitation of natural resources is concerned, at least under current market conditions and given the present state of technology. The frantic investments in infrastructure and housing in the 1960's would seem to have meant that sand and gravel consumption reached its peak at that time, and peak production in mining was evidently achieved in 1974, some 2.5 mill. tonnes, since when figures had declined to about a half of this by 1980. This points to a considerable reduction in physical materials flows. Production in agriculture and forestry in Northern Karelia increased slowly in the 1960's and 1970's.

The exploitation of natural resources is nevertheless crucially dependent on market conditions. One new, rapidly growing form of exploitation in the region in the 1970's was peat production, even though it accounted for a relatively minor proportion of total production. This expansion may well have levelled off with the crash in oil prices in 1986, although the demand

for peat as a fuel may equally probably increase again as public opinion turns away from nuclear power.

The economic transition has meant that exploitation of the environment has increased much more slowly than production as a whole. The power requirements and pollution hazards attached to the new industries are minor compared with those of the sectors traditionally emphasized in the economy of Northern Karelia, and since the amounts of waste generated by both types of industry are extremely large, the shift in focus towards industries which are independent of local natural resources is likely to lead to a substantial reduction in the growth in waste products. A further factor which will retard the growth in pollution from certain sectors of the economy is progress in production technology. Other things being equal, any reduction in pollution is likely to improve the environment for those living in the area.

Since the changes in the structure of the economy discussed above and the progress being made in technology will have the effect of retarding the growth in environmental loading, the penetration of the industrial society into the periphery should not mean any worsening of living conditions there. Utilization of natural resources and damage to the environment are to a great extent dependent on the technological choices made in the region and the sectoral structure which emerges there.

Resource processing, new industries and core functions

Differences between sectors

The sectoral differences that have emerged in the course of this work are of importance as far as regional development theory is concerned. These theories often presuppose some degree of sectoral interpretation (see Smith 1981: 395), even though generalization from models of different types, e.g. export-base, cumulative causation, trickling-down or polarization models, or Frank's dependence model, can easily spread to cover the whole of the regional economy and thereby prove inadequate. Sectoral differences are also significant from the point of view of resource management and industrial ecology, approaches in which one may also make contributions to the understanding of regional develop-

Table 20. Production types. Technology levels typical of each area (core-periphery) are used in constructing the typology.

	Core functions	Resource type	Light manufacturing
Extraction and processing of natural resources	negligible	signif.	low
Multiplier effects of resource use and waste	—»—	—»—	—»—
Power consumption in industry	low	—»—	—»—
Industrial waste generation	—»—	—»—	—»—
Material efficiency	—»—	—»—	—»—
Profitability	high	poor	high
Capital requirements for machinery and equipment	low	signif.	low
External dependence (natural resources, semi-manufactures, final products)	—»— imports	—»— exports	imports and exports
Salary level	high	low	low
Wage level	fairly high	(fairly high)	low
Staff/wage-earner ratio	high	low	low

ment and interpretations of core-periphery structures.

Peripheral regions, even in Finland, are to greater or lesser extents heterogeneous in the individual features of their utilization and processing of natural resources, and such differences in the amounts of the resources used and the processes applied to them affect the details of the core-periphery structure in different regions and at different areal levels.

Peripheries at the regional level are intra-regionally heterogeneous in their industrial characteristics. The small number of factories operating in the resource-based sectors exercise a profound influence on employment, the utilization of natural resources, the extent and nature of waste loading, etc., whereas the more even distribution of primary production (agriculture and forestry) serves to smooth out the areal features of materials and power consumption and their multiplier effects bind the locally differing systems of production together into a single interactive entity. The new industries and core area functions differ qualitatively from the resource processing sectors to a very marked extent.

Three production types may be set up on the grounds of differences in the specific features attached to resource-based sectors, resource-independent industrial functions and core area functions (Table 20). The effects derived from

the development of resource-based and resource-independent industries are taken from the results presented in Chapters "Core-periphery structure ..." and "Revising ...". These three types are referred to as the resource type, the light manufacturing type and the core function type, the results concerning the last of which are to some extent hypothetical and rely for their evidence mainly on the data obtained in this work regarding the Helsinki region. This core function type may also in part be thought of as representing the essential characteristics of the information society (Kuusi 1986).

This typology is highly relevant to the theory of regional development and its interpretation in terms of human ecology. Industrial functions differ in their economic, social and environmental repercussions, and the chief emphasis needs to be placed in each case upon the mutual dependences between the features within each production type.

The structure of a regional economy may then be looked on as a combination of realizations of these production types. In the case of Northern Karelia the structure is to a considerable degree still dominated by the resource type, but development in recent times has been progressing towards the light manufacturing type. The spatial division of labour in both of these is maintained by a set of features regarded as typically

peripheral, e.g. external dependence, a given income level.

The core function type describes not only core area industries as found at the national metropolis level but also regional centre functions at a very rough level and service sector dominance in general. The ratio of salaried staff to wage-earners, for instance, is usually high in cities, and especially so at the regional capital level (Tykkyläinen 1987b).

If we turn our attention away from functions and towards areas viewed in terms of these functions, the results are naturally affected by the areal division used. Individual factories can have a considerable effect on the average data for given areas even when one chooses a relatively coarse division into subareas, e.g. by provinces in the case of the periphery. Also, the production types are actuated in the form of combinations to some extent or other, in which case the structure and developmental features of the areal economy are to be understood as relative concepts.

The resource type and light manufacturing type in the above typology are largely restricted to the description of the economic structures and developmental trends of resource peripheries on the basis of empirical observations, and the three types are to be interpreted as relative concepts which alter and gain differing manifestations within the spatial system. The description of a more diverse and more intensively exploited area such as the province of Uusimaa would require a typology of its own.

Growth and development

Continuation of the transition

At the present moment, in the mid-1980's, it may be said the the primary sector — industrial sector transition in Northern Karelia is still in progress, and forecasts suggest that employment in primary production will continue to fall very considerably until around the year 2000 (Chapter "Revising ..."). The rapid growth of industry would not mean an immediate solution to the region's employment problems, however, for the labour supply will almost certainly remain ahead of the demand. The extent of this problem is reflected well in the fact that where total employment in industry (SIC 2—4) in Northern

Karelia in 1983 was 12 917, the region regularly had a total of 6000—9000 persons unemployed in the early 1980's.

There are thus certain problems peculiar to the resource periphery which do not trouble the more developed regions to anything like the same extent, e.g. the decline in primary sector employment, which has admittedly slowed down but is still a force to be reckoned with, and higher than average unemployment. These are in turn related to the domination of the periphery by resource-based sectors of industry, which, as sector theory maintains, are not especially expansive.

Effects of the structure of production: growth propensity

A stagnant structure of production is reflected in a poor propensity for growth. A summary of the developmental alternatives obtained here by linear programming (alternatives A and B) and subjective evaluation (alternatives I—IV) is presented in Fig. 31, together with an estimate of their structural features. The growth propensities attached to these alternatives are calculated based on the work of Kässi (1982: 21—79), but weighting his sector-specific annual growth percentages by the employment figures for the respective sectors in the given alternatives to obtain mean growth percentages for the alternatives themselves. The figures represent growth propensities for the 1980's, the left-hand percentage given in Fig. 31 applying to Kässi's rapid growth scenario (mean annual growth in the national economy 5.5%) and the right-hand figure to his slow growth scenario (mean annual growth 3%).

Estimated in this way, the structure of production in the initial year for the calculations, 1978, would imply a much slower rate of growth than in the national economy as a whole, while almost without exception the alternative projections involving an increase in the new industries show a higher growth potential than those based on resource processing, regardless of whether one adopts a rapid or slow growth scenario (alternatives A, III, II and IV in Fig. 31). This scheme is confirmed by the data for employment in industry in Northern Karelia over the period 1978—83, which again show growth in the new industries to be many times greater than that in the resource-processing sectors (section "Comparison ...").

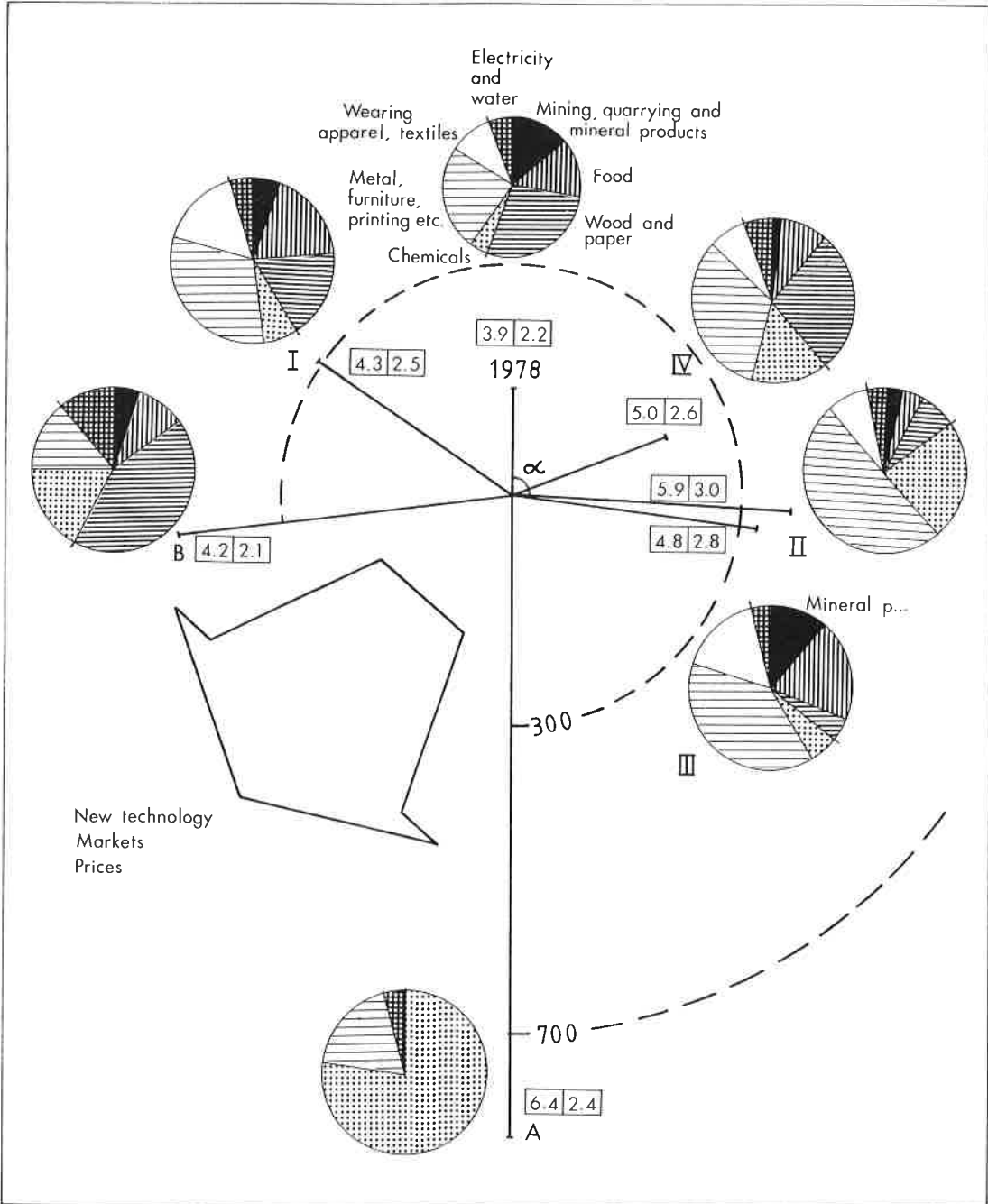

Fig. 31. Alternative structures of production for Northern Karelia. The lengths of the lines denote the net returns in mill. FIM and the angles the alpha values (= sum of total changes in employment relative to the employment level in 1978). An alpha value of 10 degrees = .1117. Alternatives involving an increase in employment in resource processing industries compared with 1978 are on the left and those involving a decline in such employment on the right. The figures denote the growth values for the alternatives (see text).

The above results lend support to the *sector theory view of economic transition*, and also provide empirical backing for the classical explanation concerning the effect of profitability on restructuring. Development forecasts grounded in past figures are always somewhat uncertain, however, although they usually point successfully to the general trend involved. Where one is dealing with a relatively small area, of course, even individual investment decisions can alter the growth figures for the whole region quite markedly if they apply to large employers. It is obvious, however, that the traditional system which relies on multiplier or spin-off effects cannot alone generate any appreciable growth.

Inevitability of reorganization and renewal

The economic results achieved by industry in Northern Karelia can be improved by means of both structural and technological reforms (Chapter "Revising . . ."). Further development of the resource-based sector would require reorganization and streamlining and the creation of new opportunities for further processing of the products, all of which would in most cases, e.g. paper mills, call for substantial capital investment. The results obtained with the optimization and simulation models nevertheless suggest that this direction of expansion would offer few openings for solving the employment problems of the resource periphery concerned given the present level of technology. Diversification of the economy *into new spheres* would seem to be the inevitable course.

As the new industries gain ground, the economy of Northern Karelia is becoming more open and less able to rely on the advantages of possessing its own natural raw materials. The shorter life-spans of the new products and the footloose type of location decision involved may well leave the economy less stable than before, e.g. with respect to employment, although contradictory results have been presented regarding the instability that may be associated with these industries (Erickson 1981; Harrison 1982). This path of development offers in theory better chances of expansion, however, as demand for the products of these new industries usually increases more rapidly than that for basic commodities such as foodstuffs, timber, paper, ores, etc.

This resource periphery thus has a greater than usual need for industrial reorganization and the replacement of unprofitable functions. The question of how to avoid profitability problems and

an over-representation of stagnant branches of industry can be answered only by continuous *adaptation* to market conditions.

The industrial periphery

The growth sectors in most market economies since the mid-1970's have proved to be those that make more than average use of (scientific) research, discoveries and inventions (the 5th Kondratiev wave: see Rothwell 1982). The spatial division of labour is much in evidence in these new industries, and the production of new technology in peripheral areas would seem in part to match the behaviour of the new industries that have reached these areas. Research performed in the U.K. suggests that employment in a periphery will be dependent on innovations created in the core areas (Vuorinen 1985). In Finland the pronounced emphasis on salaried employment in the south of the country is further evidence of this spatial trend. The 5th wave, and peripheral development as a whole, would thus seem to be following the model proposed by Hautamäki (1985) in which the various stages in social evolution (primary production society, industrial society, information society) arrange themselves outwards from a 'core' in the south towards the periphery.

At the same time, however, the problems generated by overcrowding can lead to the intentional siting of administrative, research and other core area functions outside the major traditional core areas. This stage in social evolution can be particularly significant for a periphery if it involves contributory functions which can make use of local resources. One of the most recent developmental trends is the attempt to stimulate local business activities in peripheral areas. With some 500 small businesses founded in Northern Karelia within a short space of time (in the years 1982—86) as a result of subsidies of various kinds (commencement grants for the unemployed, rural employment subsidies, etc.), this venture cannot fail to be reflected in the industrial structure of the whole regional economy (Tykkyläinen 1987c). These potential effects of recent branches of production and business enterprise are represented by the arrow in Fig. 31.

The main trend since around 1970 has nevertheless been for peripheral regions to become specialized as areas in which actual production takes place while the administrative and marketing functions are confined to the centres. Even

if quite pronounced deurbanization were to take place in Finland (cf. the results of Illeris in Palomäki 1982), the core area functions could easily become concentrated all the more unless an adequate infrastructure is created beyond the level of the national metropolis. The spatial division of labour has spin-off effects of its own, and all the time service functions and the quaternary sector remain in the developed regions the areal discrepancies in standard of living, educational standards of the labour force, etc. are bound to remain and take of new manifestations. In other words, the resource periphery will become an *industrial periphery*, i.e. one in which process functions are overrepresented (process linkages: see Wood 1969; Törnqvist 1978).

Most process linkages require a hard infrastructure (road network, industrial premises, investment incentives, etc.) in order to develop, while other linkages require a soft infrastructure (organizations to promote their activities, communications, research). Improved access to high-level services could provide peripheral areas with better opportunities for performing functions connected with the administration, direction and planning of both local and branch plant-type production in the peripheries. This would promote the emergence of an industrial environment, improve the general conditions for business activities and stimulate the development of innovations. In other words, it would provide an opportunity to reduce the technological and organizational discrepancies between peripheries and core areas.

Self-sustained growth and innovations

Entrepreneurship, innovations and infrastructure requirements become fairly critical factors in peripheral regions possessing an abundance of production facilities, natural resources, labour and even capital (Mäkelä & Virtanen 1986). It is the mobilization of intellectual and institutional resources that is thus of prime importance and often constitutes the bottleneck from a resource management point of view. The importance of entrepreneurship and innovations has traditionally been emphasized in growth theories (see Schumpeter 1934), but the former at least is frequently a very minor element in regional development theories, where examination of a regional economy as an aggregate tends to remain at the level of production factors and the concept of sector is restricted to production at individual fac-

ories or sites. Entrepreneurship (formation of companies, taking of risks, etc.) is nevertheless an underlying condition for the functioning of a market economy, and one which has undoubtedly been undermined by the penetration of the branch-plant economic model into the peripheries and by the adoption of a range of agricultural subsidies. Similarly the regional policy measures of the 1960's and 1970's did not favour company formation at the local level in any explicit sense. It is only in recent years, with the introduction of business management courses and local business subsidies that significant opportunities have opened up for a more extensive promotion of small businesses, and the peripheral areas have provided an extensive breeding ground for this (see Aho & Ilola 1985).

The use made of innovations for renewing the structure of an economy is dependent on three conditions: the generation of new innovations, the diffusion of knowledge regarding these innovations, and the spread of a pattern of adoption. When we look at the operation of small businesses in a peripheral economy it is obvious that there is no shortage of innovations, in the form of the ideas upon which these businesses are based, but it is equally true that the real high-tech innovations arise in the places where the extensive research and development work is done, i.e. principally in the core areas, from which they are then transmitted to the periphery via a variety of diffusion mechanisms.

The conditions under which innovations can arise at the business level are discussed by Thomas (1972), who defines the factors affecting the innovation response of a company. These include the relative size of the company, its growth rate, its profit position, its liquidity position, the anticipated profitability of the new technology, and the age of the management. Peripheral areas have few companies of the kind referred to here, and thus the generation and adoption of innovations is highly concentrated in spatial terms, suitable frameworks being created by means of territorial innovation complexes of various types (Stöhr 1986). The extent to which these are formed in the regional structure of a peripheral area and at what level does not fall within the framework of this research.

The new industries and many of the small business functions belong to sectors growing more rapidly than the traditional staple industries, or else they are able to find new niches in the markets. At any rate, they are not bound by established markets and production systems and the

constraints of resource exploitation in the same way as the traditional resource-based industries are, so that both the new industries and the branches of resource processing creating 'new' products constitute major factors in regional development.

Industrial strata in the core-periphery relations model

It was shown in Chapters "Core-periphery structure ... " and "Revising ... " that the resource-based and new industrial sectors differ greatly in their spin-off effects. This means that the economic transition will give the resource periphery new *industrial strata* alongside those belonging to its traditional sectors, which will naturally affect the structure of the core-periphery model, even though the new industries have relatively little impact on exploitation of the environment, whereas development of the resource frontier type would undoubtedly increase exploitation quite substantially and introduce new elements into the materials flows. The development of small businesses and new technology will bring with it new features, so that the typology presented here, involving a resource type of economy and a light manufacturing type, could be filled out with new, less dichotomous features.

Many of the basic structures of the resource periphery would seem to be fairly permanent in character, e.g. the division of labour, the greater than average importance of the resource-based sector, etc. (section "Core-periphery relations ..."), and the changes taking place in the name of regional development concern mostly economic growth, since the existing structure is relatively slow to change. Thus most of the dependence relationships pointed out here will hold good for some time to come, until the machinery of production and the sectoral structure have changed in some essential way. Economic transition similarly need not imply an abandonment of resource processing, for this stratum will almost certainly remain part of the structure of production in the periphery as it has done in more advanced areas. As far as the opening of new factories is concerned, however, the developmental strategy to be adopted is very much a matter of regional and industrial policy, and depends on the conditions which one wished to attach to development and constraints and opportunities engendered by international economic development.

A discussion on further development

Transition in a periphery — a framework for further development

Since peripheries prove to be predominantly resource-exploitation regions, recessions in the resource processing sectors turn them into downward-transitional areas in the developmental sense and expansions into upward-transitional areas. When limits exist to the extent of the development that can take place in these sectors, due to the slow rise in demand or restrictions on the use of natural resources, a peripheral area cannot undergo any very great expansion within the context of its prevailing regional economy. Expansion is also being restricted at present by the rationalization taking place in many processing branches of industry, the orientation towards larger individual factories and the tendency for further processing of the products to follow market trends.

At the same time rationalization in primary production and the slow rate of growth in markets for staple products generate contraction pressures, the magnitude of which will depend on the structure and nature of production in the resource periphery concerned, the need for rationalization and market trends. Any significant increase in employment is likely to occur outside the traditional sectors, implying a shift towards the newer branches of industry in the periphery, encouraged by infrastructure changes and dependent on the suitability of the production process concerned for implementation in a peripheral area. It is also the case to some extent that changes in cost levels and the employment situation in the traditional industrial areas can tempt production processes and parts of these into the periphery. Similarly, official attitudes expressed in terms of regional policy, industrial policies, agricultural policy, etc. affect the conditions under which production takes place and are thereby actuated in the form of influences for either growth or recession. Companies, processes and functions filter into the periphery in cases where these are adaptable to the conditions prevailing there.

The growth of industry in the resource peripheries has evened out the discrepancies that existed between the developed areas of the country and the development regions as far as the degree of industrialization was concerned, but the

resource peripheries still retain certain developmental features, e.g. selective growth, recessive industries or industrial periphery status, which continue to generate regional problems, problems which apply in a highly heterogeneous manner, both sectorally and spatially.

Control functions (main office functions) and practical production processes are liable to separate out on an areal scale both within given sectors of industry and within individual companies, constituting a spatial division of labour that has become more accentuated in the long term. The material interaction between core and periphery takes the form of a complex interchange between different parts of the core-periphery network, leaving the core area at the national level with a largely organizational role. The change in industrial structure, i.e. the increased accent on the newer industries, still leaves the periphery dependent upon external markets, although in different ways from before. If anything, it is more susceptible than ever to outside influences, especially imports of semi-manufactures and is restricted largely to assembly functions.

The rise of the new industries means an increase in functions involving a low environmental loading and low power input. By its very nature, a resource periphery lies on the margins of the national economic system and does not attract power-intensive process industries or ones which make use of externally obtained raw materials. At the same time advances in technology and the norms placed upon industry serve to restrict the increase in environmental problems. Thus it seems that exploitation of the environment is likely to remain on a fairly extensive level for some time to come.

The traditional forms of exploitation of natural resources present few opportunities for expansion as rationalization advances in these sectors

and expansive pressures become increasingly concentrated upon the further processing of the products. A functional environment suitable for the development of opportunities for exploiting natural resources does exist in the resource peripheries, e.g. exploitation could be increased quite substantially in Northern Karelia before the physical environment would constitute a barrier (in terms of available timber, water supplies, etc.), but, with the possible exception of the wood processing sector, this growth should be looked for under present market conditions somewhere beyond the traditional range of products.

The expansion in industry is able to offer only a very limited number of jobs for the growing amounts of free labour being released from primary production, and in the light of the progress being made in rationalization and automation and the range of measures available within the scope of regional policy and labour policy, one is forced to take a somewhat sceptical view of the significant and rapidly implemented employment effects to be achieved by the introduction of new industry, i.e. in the balancing of supply and demand on the labour market. The problems of rationalization and the general competitiveness of industry (and thereby also of deindustrialization) are bound to be reflected in the periphery and to retard the growth of new industry there.

International competition and continuation of the transition

Northern Karelia, on the periphery of an advanced industrial society, is facing new challenges in its economic development. The foundations for this discussion are somewhat speculative, but problems of at least the following kinds may arise:

PHENOMENON:

Increasing mass production, freer trade, economic expansion in the NIC countries

Consequences:

- narrower ranges of goods
- specialization
- resource processing

POSITION OF RESOURCE PERIPHERY:

Limits expansion of standard production of the branch-plant type in particular

Limited opportunities, as the periphery is a recipient of innovation via diffusion

Position in different sectors determined by general price competition, limited supplies and substitution, markets growing slowly

Technological progress

- rationalization, robotization
- growth industries
- soft infrastructure
- agglomeration
- decentralization of industries

Reduced employment in assembly functions in particular

Underrepresented, few high-tech companies
deficient

deficient

See spatial division of labour, growth industries, soft infrastructure

Non-polluted environment

- agro-industrial production
- locational factor for selected industries
- quality of life

Expansion possible if demand is directed at resource periphery products

Plenty of land, good water, supplies, little pollution

Good place to live in, although remote

Spatial division of labour

- jobs of an assembly type, technology, know-how
- services

Industrial periphery phenomenon

Growth opportunities limited and in some cases selective

Values of post-industrial society

- changes in demand
- concept of employment, leisure time

See specialization, non-polluted environment; slow growth propensity

Relieves unemployment

Regional policy

- problems in industrialized regions

Distribution of regional policy advantages

These features are liable to affect development in the periphery, creating problems of imbalance, but also opening up new opportunities. The list speaks of deficiencies in both industrial structure and infrastructure and of global effects being brought to bear on development in peripheral areas. Industrial structure can be altered only by dint of restructuring, alteration in a more growth-responsive direction being likely to lead to more rapid growth stimulated by demand.

The transition away from traditional resource processing of a bulk kind towards new branches of industry will frequently mean adaptation to product cycles, company-specific product development work and often also small production units. Marketing, too, will become more specific to individual companies. The development of ancillary commercial functions and other core functions would increase the advantages offered by the area as an industrial environment as far as company administration and product development are concerned, and would thus indirectly reduce the danger of an increased intra-firm di-

vision of labour. In more general terms, the promotion of a soft infrastructure, e.g. research and development, can be expected to diversify the environment in which business is carried on in this way foster the progress of small companies.

Since production in a resource periphery is based to a great extent on the availability of raw materials and the existence of large industrial establishments, business activity as a whole is of necessity less well developed than in more industrialized areas. Diversification has up to now mostly taken the form of an increase in branch-plant production, and the potential for local business initiatives has been perceived only in very recent years (cf. Aho 1985; Tykkyläinen 1987c), largely based on the opportunities offered by specialization and the exploitation of local advantages. This line of development does not necessarily mean total divorce from the resource base, for the raw materials obtainable locally are themselves one form of locational advantage justifying the creation of new resource processing functions and allowing this branch of indus-

try, too, to assume new forms within a diversifying regional economy.

The above list of phenomena, consequences and resource periphery problems demonstrates that even in such a peripheral area one is obliged to operate in a situation of powerful international *competition*. The growth and development opportunities open to small companies are derived very largely from the conditions prevailing in the global economic system and the changes taking place in this system, changes which apply to almost every sector of the peripheral economy.

Conclusions

Theoretical observations — applicability of the theory to a resource periphery

One initial assumption for this work, as stated in section "Orientation . . .", was that utilization of natural resources plays a major part in economic development in a resource periphery and in determining the nature of the economy. One may now ask to what extent new concepts are required in order to interpret regional development in a peripheral area and what these concepts should be.

The trends observable in the utilization and processing of natural resources are able to explain to a considerable extent the transition which took place in the economy of Northern Karelia from 1960 to 1980 and the problems associated with the industrial structure of the region in the subsequent years. The problems are relatively diverse in nature, e.g. rationalization in agriculture, profitability problems in the wood processing industry, exhaustion of the raw materials required for mining, the footloose character of the new industries, etc. A number of sectorially and spatially different directions of development are detectable in this resource periphery, and it is in this that the *periphery syndrome* which troubles such areas lies: the combined effects of a large number of factors, resulting in discrepancies in affluence and more generally in areal differentiation in the economic sphere. The problems include poor economic viability, rationalization, organizational and technological deviations, poor growth propensity, selective growth etc. This syndrome is dynamic in nature, in the sense that the chief problems afflicting Northern Karelia are shifting from the sphere of rationalization in

agriculture to structural difficulties within industry. This introduces a number of dynamically changing developmental features into the basic model as outlined in section "Core-periphery relations . . .". One common factor is nevertheless that development in the periphery can be explained to a great extent via the functioning of the resource-based sectors.

The important thing as far as regional development is concerned is the difference in types of development existing between sectors, emphasizing that the theory requires note to be taken of *sector-specific* differences. Interpretation of the transition from primary production to industry in a resource periphery and also explanation of resource use and its social and environmental spin-off effects call for theoretical and empirical frames of reference which will focus attention on the more critical elements of regional development (Fig. 32). These frames of reference may be conceived of in terms of models comprising theories and theoretical conceptual systems, which may be used to add the necessary dynamic dimension to the core-periphery model put forward in section "Core-periphery relations . . .".

A *population model* can be used to explain trends in the labour supply. In the case of Northern Karelia it was in part no more than a historical accident that the population boom happened to come just as the transition was at its height, although it is true that communities dominated by primary sector occupations usually tend to have different population structures and rates of population growth from industrialized and post-industrial communities. A *rationalization model* is required to explain the changes in employment that have taken place in the primary sector and to deal with productivity in different branches of industry. A transition usually brings with it various regional policy measures aimed at guiding industry, primary production and services along certain prearranged lines. A *regional policy model* also needs to take these three sectors into account: growth in industry and the service functions and rationalization in primary production. The spatial division of labour then plays a distinct part in shaping the structure of production in the periphery, so that a *spatial division of labour model* may be linked with developments in the spatial conditions for industry, location factors and regional policy. On the other hand, the background to selective growth in a resource periphery would appear to involve spatial cost structures and features associated with infrastructure development, so that the spatial division of

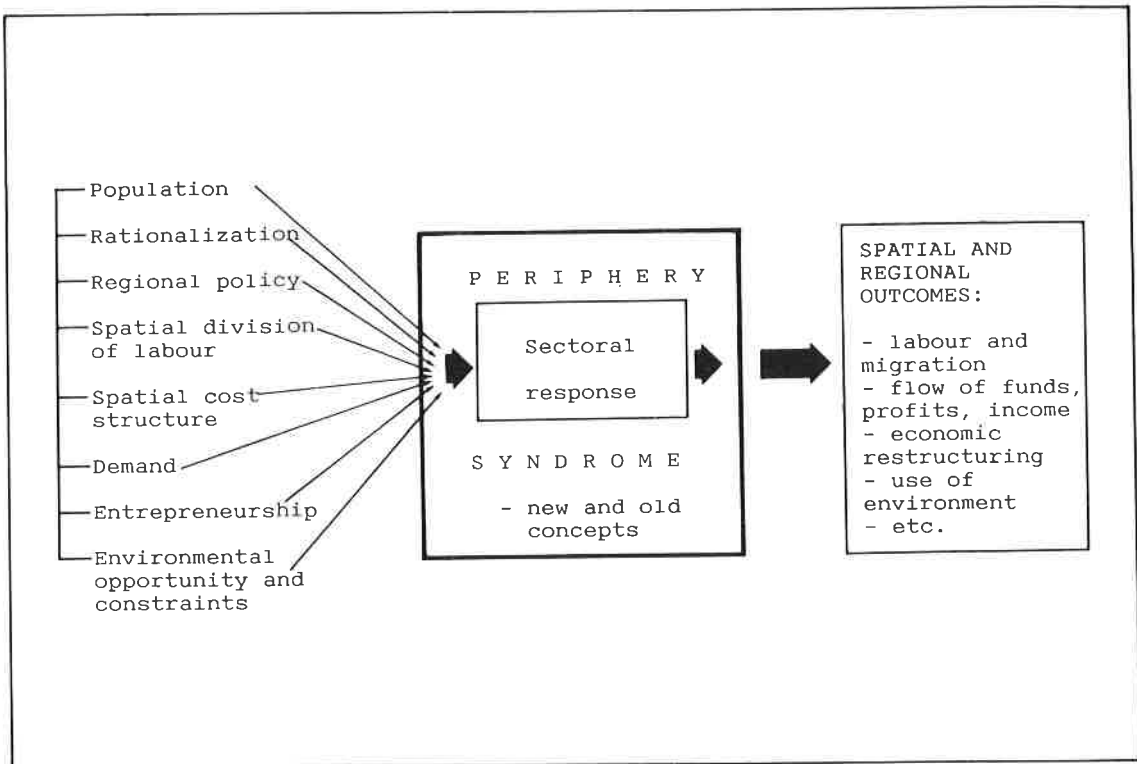

Fig. 32. Elements explaining regional development in a resource periphery context. See text.

labour model has to be filled out with a *spatial cost structure model*. Any explanation of the change which has taken place in the peripheral economy also needs to be interpreted in terms of sector theory, however, and thus the related *demand model* also becomes an important explanatory variable for regional development.

Very little is said of entrepreneurship in theories of regional development, and thus an *entrepreneurship model* is required to describe the formation of small private companies, the generation of innovations and their diffusion and adoption. One fairly important need in resource peripheries is for a channelling of the free enterprise manifested in primary production into new sectors of the economy now that labour, capital, natural resources and management experience are available following the rationalization of primary production. An *environmental opportunity and constraints model* would be able to interpret questions of industrial ecology and describe the potential and the limitations contained in the projected new branches of industry. Since the relations contained in the above

models are also closely linked one with another, the models should be mutually interactive (Fig. 32).

The results presented here and the theoretical interpretations given to them are the outcome of a testing of earlier ideas, theories and models and their application to the analysis of new phenomena. This theory, too, makes use of concepts such as industrial dispersion, rationalization, multiplier effects, the spatial division of labour, locational subsidy effects, income elasticity, etc. to describe and explain regional development, improving the explanatory potential of the model by the introduction of such in this study defined concepts as industrial periphery, developmental paradox, dominance effects of recessive and stagnant sectors, technological and organizational deviations and selective growth. These are called new concepts in Fig. 32.

Although an attempt at simplification has been made here in order to search out the essential features of development in a resource periphery, the eventual result is still highly complex compared with the models that we are accustomed to meet-

ing with as explanations for regional development, and particularly compared with the generalized forms of these to be found in textbooks, where export-base theories, growth pole theories, theories of polarized growth, neoclassical theories of regional development, cumulative causation theories, etc. are mostly used one at a time as explanatory concepts. The reason why the end product is so complex lies in the different courses of development experienced by the different sectors of the economy and the different sets of distinctive features attached to these in a peripheral region.

The theory of development in a resource periphery is a combined *product of many external and internal factors and individual sectoral factors*, yielding and explanatory model composed of a number of paths of development and theoretical concepts of differing types. The practical consequences of development, in terms of affluence, migration, etc., represent combinations of these trends and distinctive features embodying past development (Fig. 32).

To what extent can the development taking place in Northern Karelia be used a general model? It is certainly the case that the same fundamental mechanism is operative in other parts of Finland, although proceeding at a slower tempo than in Northern Karelia, and the spin-off effects of the transition have not been so spectacular. Coincidences between a population boom and rationalization, causing imbalance on the labour market, are encountered in very many countries.

This discussion of the transition in Northern Karelia has brought to light development mechanisms which are by no means unique to the present case, and the theoretical conceptual framework created here can be used to estimate what would happen in connection with rationalization in agriculture, what kinds of multiplier effects can be expected from the introduction of new industries, etc. on a broader scale. Some of the answers will be specific to the areas concerned, and some of the problems will be non-repeatable in the same area (e.g. the changeover from agriculture to industry and service functions), but others will be more permanent features, applying to various phases in the transition (e.g. selective growth).

Methodology

Mathematical and statistical modelling methods have usually played a major part in

studies of regional development, and this has also been the case in the present work. The results obtained using materials flow analysis and linear and simulation models were highly informative and clear. The practical problem lay only in the laborious work of constructing them. These models apply in principle to single regions and operate in a bottom-up manner.

Inclusion of the physical environment in the analyses was achieved by employing variables expressed in physical units as indicators of resource use and waste generation, the quantitative data serving to point out the physical conditions and effects lying behind the production processes. One problem was that the values assigned to resources and wastes vary greatly, and it would have been hard to incorporate zero-value resources, and particularly wastes, into an analysis of this kind. Thus artificial values had to be assigned to all of these. Volume data could have been used in the linear programming model chiefly in the constraints placed upon production, while the simulation model required data of this kind for determining the levels of production in the resource processing sectors. The use of such data facilitated construction of the model and simplified interpretation of the results, whereas in the case of the materials flow model the volume aspect raised innumerable problems of data acquisition.

The optimization method and the intuitive evaluations backed up by the simulation model may be regarded as complementary. The intuitive method describes the respondents' subjective ideas on the present state of affairs or that likely to prevail in the near future, as of the moment of answering, while optimization provides a result which is dependent on the initial conditions. One advantage of optimization is that it can cope with large sets of quantitative parameters, while the intuitive method reflects the subjective values and non-quantifiable parameters which are normally involved in decision making. A model of the present kind could be used as a tool in a predictive evaluation of developments in a regional economy employing the Delphi technique (cf. Chadwick 1971; Kuopion . . . 1983). One nevertheless has to face the fact that neither method allows us to know anything more than what has been gleaned from the past.

If one wished to extend the application to cover a whole area of the economy, or if the geographical area concerned were to represent a significant proportion of the national economy, a weighted multi-region approach would have to be applied

to the results obtained from the bottom-up model. This would create a framework in which the development of the whole national economy could be examined in a balanced manner. On the other hand, when one is dealing with a small area such as Northern Karelia a single-region model is quite adequate, for since this area has little impact on the structure of the national economy, conclusions can be reached fairly independently of the latter. Single-region approaches are in any case justified on regional grounds, in that they represent attempts to achieve an optimal allocation of industrial functions among the parts of the one region.

An evaluation may also constitute an analysis of a national economy in which case the spatial effects are a consequence of the optimal allocation of the economy as a whole. This allows the differences between a single-region analysis and a national economy to be examined with particular reference to the spatial division of labour. The chief question to arise when comparing the evaluation principles is then how and to what extent the alternative structures for the national economy determine the regional division of labour and whether this is an advantage or a disadvantage compared with a purely regionalistic set of criteria. Incongruities of the same kind can also arise in the case of weighted multi-region evaluations.

In contrast to the multi-region or national approach, one may choose to operate at a level below that of the province, extending the areal dimension of the simulation model to allow the initial data, i.e. sectoral employment figures, to be recorded for smaller areal units, e.g. individual communes. This will place primary emphasis of the industrial preferences and interests of the

smaller areal units, which can then be combined to provide a description for the whole region, e.g. province.

The construction of models representing the structure and development of a regional economy and the preparation of the necessary bodies of data make up a lengthy, time-consuming process, and the results are empirical generalizations which change with time as society itself changes. Detailed information of practical application very soon goes out of date. The structures represented in models, on the other hand, are relatively permanent, and when they are to be developed further the original structures are still for the most part valid as building materials for this purpose. With advances in communications technology, i.e. in the real time age, the data to be transmitted can be adapted rapidly to serve as the parameters or parameter estimates in models like those used here, and in this way it should be possible to monitor changes in regional development patterns and produce new scenarios with greater rapidity.

ACKNOWLEDGEMENTS

The author is indebted to Professor Juhani Hult for the part that he has played as supervisor of this work and to Professor Kauko Mikkonen and Professor Arvo Naukkarinen for kindly reading through a very early version of the manuscript, also to Mr. Malcolm Hicks, M.A., for the English translation. Thanks are likewise due to the Academy of Finland, Suomen Kulttuurirahasto and the University of Joensuu for financial support. Finally I express my deepest thanks to my wife Eija and daughters Laura and Noora for their understanding and patience during this work.

REFERENCES

- Airaksinen, Timo (1978). Tutkimus kannattavuuden mittaamisesta ja komponoinnista. *Teollistamisrahoisto* B 1. 95 pp.
- Aho, Seppo (1985). Small-scale Enterprises as Agents of Innovation and Structural Change in a Peripheral Region: the Case of Finnish Lapland. Paper presented in RSA XXV European Congress, Budapest, 27—30 August 1985. 16 pp. Mimeo.
- Aho, Seppo and Heli Ilola (1985). Lapin pienyrittöiden tukemiskokeilu. *Työvoimaministeriö, Työvoimapolitiittisia tutkimuksia* 57. 129 pp.
- Alueellinen kehittyneisyys (1979). Tutkimus elinolojen ja hyvinvoinnin alueellisista eroista 1975. *Valtioneuvoston kanslian julkaisuja* 1979: 3. 92 pp. + app. Helsinki.
- Andersson, Jan Otto (1976). Studies in the Theory of Unequal Exchange Between Nations. *Publications of the Research Institute of the Åbo Akademi Foundation* 9. 191 pp.
- Anuchin, V. A. (1973). Theory of geography. In Chorley, Richard J. (ed.): *Directions in Geography*, 43—63. Methuen and Co, London.

- Aston, A. R., R. J. Millington and J. D. Kalma (1972). Nutrients in the Sydney Area. *Proceedings of the Ecological Society of Australia* 7, 177—91.
- Atlas of Finland* (1983). Folio 241. Industry. National Board of Survey and Geographical Society of Finland. 31 pp. + app.
- Ayres, Robert U. (1978). *Resources, Environment, and Economics*. 207 pp. John Wiley and Sons Ltd, New York.
- Ayres, Robert U. and Allan V. Kneese (1969). Production, Consumption, and Externalities. *The American Economic Review* 59, 282—297.
- Barlowe, Raleigh (1978). *Land Resource Economics*. 635 pp. Prentice-Hall, Inc., Englewood Cliffs, New Jersey.
- Berry, Brian J. L., Edgar C. Conkling and D. Michael Ray (1976). *The Geography of Economic Systems*. 529 pp. Prentice-Hall, Inc., Englewood Cliffs, New Jersey.
- Birch, J. W. (1973). Geography and Resource Management. *Journal of Environmental Management* 1, 3—11.
- Boudeville, J. R. (1966). *Problems of Regional Economic Planning*. 192 pp. Edinburgh University Press, Edinburgh.
- Boulding, Kenneth E. (1966). The Economics of Coming Spaceship Earth. In Jarrett, Henry (ed.): *Environmental Quality in a Growing Economy*, 3—20. The John Hopkins Press, Baltimore and London.
- Britton, John N. H. (1978). Influences on spatial behaviour of manufacturing firms in Southern Ontario. In Hamilton, F. E. (ed.): *Contemporary Industrialization. Spatial analysis and regional development*, 110—121. Longman, London and New York.
- Brobst, Donald A. (1979). Fundamental Concepts for the Analysis of Resource Availability. In Smith, Kerry V. (ed.): *Scarcity and Growth Reconsidered*, 106—142. The John Hopkins University Press, Baltimore.
- Brookfield, Harold (1975). *Interdependent Development*. 234 pp. Methuen and Co, London.
- Butler, Joseph H. (1980). *Economic Geography*. Spatial and Environmental Aspects of Economic Activity. 402 pp. John Wiley and Sons Ltd, New York.
- Chadwick, George (1971). *A Systems View of Planning*. 390 pp. Pergamon Press Ltd, Oxford.
- Chapman, J. D. (1976). Natural Resource Developments in Canada 1970—75. *Canadian Geographer* 20: 1, 15—40.
- Chorley, Richard J. (1973): Geography as human ecology. In Chorley, Richard J. (ed.): *Directions in Geography*, 155—169. Methuen and Co, London.
- Christaller, Walter (1966). *Central Places in Southern Germany*. Translated by C. w. Baskin from Die zentralen Orten in Süddeutschland (1933). 230 pp. Prentice-Hall, Inc., Englewood Cliffs, New Jersey.
- Ciriacy-Wantrup S. W. (1952). *Resource Conservation, Economics and Policies*. 395 pp. University of California Press, Berkeley and Los Angeles.
- Clapham, W. B., Jr. (1981). *Human Ecosystems*. 419 pp. Macmillan Publishing Co, New York.
- Coppock, J. T. and W. R. D. Sewell (1975). Resource management and public policy: The changing role of geographical research. *Scottish Geographical Magazine* 91: 1, 4—11.
- Coupe, B. E. M. G. (1976). *Regional economic structure and environmental pollution*. 166 p. Martinus Nijhoff Social Sciences Division, Leiden.
- Douglas, Ian (1981). The city as an ecosystem. *Progress in Physical Geography* 5: 3, 315—367.
- Elster, Jon (1978). *Logic and Society*. John Wiley and Sons Ltd, Chichester. 235 pp.
- Environmental statistics 1974. *Central Statistical Office of Finland. Statistical surveys* 56. 211 pp. Helsinki 1977.
- Environmental statistics 1980. *Central Statistical Office of Finland. Statistical surveys* 67. 265 pp. Helsinki 1981.
- Erickson, Rodney A. (1981). Corporations, Branch Plants, And Employment Stability In Non-metropolitan Areas. In John Rees, Geoffrey J. Hewings and Howard A. Stafford (eds.): *Industrial Location and Regional Systems: spatial organization in the economic sector*, 135—153. Bergin, New York.
- Erickson, Rodney A. and Thomas R. Leinbach (1979). Characteristics of Branch Plants Attracted to Non-metropolitan Areas. In Richard E. Lonsdale and H. L. Seyler: *Nonmetropolitan Industrialization*, 57—78. John Wiley and Sons Ltd, Halstad Press, New York.
- Eriksson, Gösta A. (1979). Ekosystem och miljövårdsökonomi. Åbo Swedish University School of Economics. *Memorandum från ekonomisk-geografiska institutionen* 45. 93 pp.
- Eriksson, Seppo and Esko Toiviainen (1978). Teollisuuden ulkoisiin sijaintitekijöihin perustuva sijoitustismalli. *University of Oulu, Department of Economics, Research Reports* 15. 118 pp.
- Eskelinen, Heikki (1980). Pohjois-Karjalan panostuotostutkimukset 1970-luvulta. *University of Joensuu, Publications of Karelian Institute* 41. 48 pp.
- Eskelinen, Heikki (1984). Regional division of labour in a semiperipheral country: locational shifts in industrial employment in Finland. *University of Joensuu, Publications of Karelian Institute* 67. 32 pp.
- Eskelinen, Heikki and Risto Sullström (1979). Kolmen aluetalouden panos-tuotostutkimus. In Eskelinen, Heikki (ed.): *Aluetalous tutkimuskohteena — menetelmiä ja sovelluksia*, 41—51. *University of Joensuu, Publications of Karelian Institute* 37.
- Ewers, H.-J. and R. W. Wettman (1980). Innovation-Oriented Regional Policy. *Regional Studies* 14, 161—79.
- Frank, Andre Gunder (1969). *Capitalism and Underdevelopment in Latin America*. Revised and Enlarged Edition. 343 pp. Monthly Review Press, New York.

- Friedmann, John (1966). *Regional Development Policy: A Case Study of Venezuela*. 279 pp. The M.I.T. Press, Cambridge, Mass.
- Friedmann, John (1973). *Urbanization, Planning and National Development*. 351 pp. Sage Publications, Beverly Hills, Calif.
- Friedmann, John and Clyde Weaver (1979). *Territory and Function. The Evolution of Regional Planning*. 234 pp. Edward Arnold Ltd, London.
- Fujita, Masahisa (1978). *Spatial Development Planning*. 335 pp. North-Holland Publishing Company, Amsterdam.
- Georgescu-Roegen, Nicholas (1971). *The Entropy Law and Economic Process*. 457 pp. Harvard University Press, Inc., Cambridge, Mass.
- Ghali, Moheb and Bertrand Renaud (1975). *The Structure and Dynamic Properties of a Regional Economy*. 158 pp. Lexington Books, Lexington, Mass.
- Glickman, Norman J. (1982). Using empirical models for regional policy analysis. In Albegov, Murat, Åke E. Andersson and Folke Snickars (eds.): *Regional Development Modeling: Theory and Practice*, 85—104. North-Holland Publishing Company, Amsterdam.
- Goddard, John B. (1978). The location of non-manufacturing activities within manufacturing industries. In Hamilton, F. E. (ed.): *Contemporary Industrialization*. Spatial and regional development, 62—85. Longman, London and New York.
- Gregory, S. (1974). The geographer and natural resources research. *S. A. Geograaf* 4: 5, 371—382.
- Haggett, Peter (1979). *Geography — A Modern Synthesis*. 3. ed. 627 pp. Harper and Row, Publishers, Inc., New York.
- Häkkinilä, Matti (1980). Areal concentrations in certain aspects of Finnish forestry. *Fennia* 158, 15—26.
- Häkkinilä, Matti (1977). Geographical aspects of forest returns on Finnish farms. *Fennia* 152. 86 pp.
- Hansen, Niles M. (1981). Development from Above: The Centre-Down Development Paradigm. In Walter B. Stöhr and R. D. Fraser Taylor: *Development from Above or Below?*, 15—38. John Wiley and Sons Ltd, New York.
- Haren, Claude C. and Ronald W. Holling (1979). Industrial Development in Nonmetropolitan America: A Locational Perspective. In Richard E. Lonsdale and H. L. Seyler: *Nonmetropolitan Industrialization*, 13—46. John Wiley and Sons Ltd, Halstad Press, New York.
- Harrison, Richard T. (1982). Assisted Industry, Employment Stability and Industrial Decline: Some Evidence from Northern Ireland. *Regional Studies* 16, 267—285.
- Harvey, David (1969). *Explanation in Geography*. 521 pp. Edward Arnold Ltd, London.
- Hautamäki, Lauri (1985). An Analysis of the Mechanism of Regional Development — A Theoretical Analysis. In Lauri Hautamäki, Olli Kultalahti and Seppo Siirilä (eds.): *Approaches to Regional Development. Two Decades of Research*, 25—70. *University of Tampere, Department of Regional Science B* 37/1985.
- Helsingin kaupunki (1978). Teollisuus Helsingissä. *Helsingin kaupungin kaupunkisuunnitteluvirasto, yleiskaavaosasto*, YB 3/1978, *toiminnallisia selvityksiä* 39. 45 pp. + app. Helsinki.
- Herendeen, Robert A. (1974). Use of Input-Output Analysis to Determine the Energy Cost of Goods and Services. In Macrakis, Michael S. (ed.): *Energy: Demand, Conservation, and Institutional Problems*, 141—158. The MIT Press, Cambridge, Mass.
- Hermansen, Tormod (1972). Development poles and development centres in national and regional development. In Kuklinski, A. (ed.): *Growth Poles and Growth Centres in Regional Planning*, 1—67. Mouton and Co, Paris and the Hague.
- Hewett, D. F. (1929). Cycles in Metal Production. *Transactions of the American Institute of Mining and Metallurgical Engineers*, 65—98.
- Hirschman, A. O. (1958). *The Strategy of Economic Development*. 217 pp. Yale University Press, New Haven, Conn.
- Holland, Stuart (1976). *Capital versus the Regions*. 328 pp. The Macmillan Press, London.
- Holt-Jensen, Arild (1981). *Geography, Its History and Concepts*. 171 pp. Harper and Row, London.
- Honkanen, Seppo, Aimo Komonen and Ilkka Vainio-Mattila (1973). Suomen maatalous 1960—1980. *Publications of the Marketing Research Institute of Pellervo Society* 14. 110 pp.
- Huggett, Richard (1980). *Systems Analysis in Geography*. 208 pp. Clarendon Press, Oxford.
- Hustich, Ilmari (1975). Kulttuuri- ja luonnonmaantieteen suhde. *Terra* 87, 32—33.
- Huttunen, Terho (1981). Suomen puunkäyttö, poistuma ja metsätase 1978—80. (Wood consumption, total drain and forest balance in Finland 1978—80). *Folia Forestalia* 465. 47 pp.
- Huttunen, Terho (1982). Suomen puunkäyttö, poistuma ja metsätase 1980—1982. (Wood consumption, total drain and forest balance in Finland, 1980—82). *Folia Forestalia* 540. 46 pp.
- Hynynen, Pertti, Tapio Leppo, Juhani Puikkonen and Kaarina Alsta (1979). Skenaariomenetelmä tulevaisuuden tutkimuksessa. *Valtioneuvoston kanslian julkaisuja* 1979: 1. 127 pp.
- Inkilä-Rauhala, Anja (1979). Eräiden valtionalouden tulo- ja menoerien tarkastelua läänien välisenä vertailuna. *Valtioneuvoston kanslian monisteita* 1979: 7. 74 pp.
- Isard, Walter (1956). *Location and Space-Economy*. 350 pp. MIT Press, Cambridge, Mass.
- Isard, Walter and Christine Smith (1983). Linked integrated multiregional models at the international level. *Papers of the Regional Science Association* 51, 3—20.
- Jaakko Pöyry International Oy (1981). Pohjois-Karjalan metsäteollisuuden kehittämistutkimus. Pohjois-Karjala toimikunta. 103 pp. + Liiteosa. Jaakko Pöyry International Oy, Helsinki. Mimeo.
- James, D. E., H. M. A. Jansen and J. B. Opschoor

- (1978). *Economic Approaches to Environmental Problems*. 234 pp. Elsevier Scientific Publishing Company, Amsterdam.
- Jansson, A.-M. and J. Zucchetto (1978). Energy Economic and Ecological Relationships for Gotland, Sweden — A Regional Systems Study. *Ecological Bulletin* 28. 154 pp.
- Järvinen, Marikki (1987). Selvitys yrityspalveluiden alueellisesta sijoittumisesta Suomessa. *Sisäasiainministeriö, aluepoliittinen osasto. Aluepoliittisia tutkimuksia ja selvityksiä* 3/1987.
- Johnston, R. J. (1983). Resource analysis, resource management and the interaction of physical and human geography. *Progress in Physical Geography* 7: 1, 121—146.
- Kalma, J. D., A. R. Aston and R. J. Millington (1972). Energy use in the Sydney Area. *Proceedings of the Ecological Society of Australia* 7, 124—141.
- Karjalainen, Pauli and Markku Tykkyläinen (1981). Luonto talouden reuna-alueella Pohjois-Karjalassa. *University of Joensuu, Publications of Karelian Institute* 45. 182 pp.
- Kässi, Tuomo (1982). Teollisuus 1990. *Etlä* B 34. 164 pp.
- Katajamäki, Hannu (1984). Näkökohtia työttömyyden kohonneen minimitason alueittaisista piirteistä. In Aho, Seppo (ed.): Reuna-alueiden kehitys. Teoreettisia, metodisia ja empiirisiä näkökulmia, 171—193. *University of Oulu, Research Institute of Northern Finland* C 48.
- Keeble, D. E. (1980). Industrial decline, regional policy and the urban-rural manufacturing shift in the United Kingdom. *Environment and Planning* A 12: 945—962.
- Kekki, Kari (1984). Den offentliga sektorns regionala sysselsättningsutveckling i Norden 1960—1980. In *Offentlig sektorn i regionalpolitiken*, 20—42. NordRefo. Oslo.
- Kiljunen, Kimmo (1979). *80-luvun aluepolitiikan perusteet*. 273 pp. Työväen taloudellinen tutkimuslaitos. Helsinki.
- Kontturi, Osmo (1980). Kulttuuri-Suomen harjumaisen tilan kehitys ja sitä kontrolloivat tekijät. (Summary: The development of the state of ensker landscape in Cultural Finland and factors controlling it). *The Nation-Wide Ensker Investigation*, 12. 96 pp. Joensuu.
- Korhonen, Markku and Markku Tykkyläinen (1983). Lieksan luonnonvaroista ja niiden hyödyntämismahdollisuuksista. *Lieksan kaupunki, Luonnonvarojen hyödyntämisprojektin julkaisuja* 1. 89 pp.
- Koski, Riitta (1979). Vaasan läänin teollisuusyritysten sijaintikäyttäytyminen. (The locational behaviour of the industrial firms in the administrative province of Vaasa, Finland). *Vaasan kauppakorkeakoulu tutkimuksia* 59, maantiede 26. 121 pp.
- Krueger, Ralph R. and Bruce Mitchell (1977). Canadian Resource Management: An Overview. In Krueger, Ralph R. and Bruce Mitchell (eds.): *Managing Canada's Renewable Resources*, 1—8. Methuen and Co, Toronto.
- Kuitunen, Jorma and Seppo Siirilä (1984). Alueellinen kehittäminen: aktiivista hyvinvointipoliittikkaa? *Tampereen yliopisto, Aluetiede, tiedonantoja* 23. 27 pp.
- Kuopion läänin teollisuustoimikunta (1983). Kuopion läänin teollisuuden kehitysnäkymät 1980-luvulla. Kuopio. 48 pp. + app.
- Kultalahti, Olli and Jukka Kultalahti (1978). Valtion rahavirtojen alueellisesta ohjautumisesta. *Valtioneuvoston kanslian monisteita* 1978: 4. 179 pp.
- Kuusi, Osmo (1986). Kohti osaamisen yhteiskuntaa. Artikkeleita tietoyhteiskunnan alueellisesta etenemisestä. *Sisäasiainministeriö, aluepoliittinen osasto. Aluepoliittisia tutkimuksia ja selvityksiä* 4/1986.
- Lääneittäinen väestö- ja työpaikkasuunnite vuosille 1985, 1990 ja 1995 (1982). *Valtioneuvoston kanslian julkaisuja* 1982: 3. 56 pp. + app.
- Lahtinen, Simo (1977). Tuotanto, työ ja energia Suomen teollisuudessa vuosina 1900—1975. *Suomen Pankki* A: 45. 78 pp.
- Laihonen, Aarno (1972). Ympäristöllisen tietojärjestelmän kehikko. *Tilastokeskus, tutkimuksia* 20. 130 pp.
- Lecomber, Richard (1978). *Economic Growth versus the Environment*. Reprinted. 96 pp. The Macmillan Press, London and Basingstoke.
- Lehmusto, Mauri (1980). Kehitysaluepoliittista tukea saaneiden teollisuusyritysten toimipaikkojen siirtyminen Etelä-Suomesta kehitysalueille vuosina 1966—1975. Talusmaantieteen lisensiaattitutkielma. Vaasan kauppakorkeakoulu. 114 pp + app. Mimeo.
- Lindgren, Jarl and Marketta Ritamies (1981). Population Development in Finland in the 1970's. *Yearbook of Population Research in Finland* XIX, 11—27.
- Lösch, August (1954). *The Economics of Location*. Translated by W. H. Woglom from Die räumlichen Ordnung der Wirtschaft (1940). 520 pp. Yale University Press, New Haven, Conn.
- LTT (1967). Liiketaloustieteellinen tutkimuslaitos. Suomen keskus- ja vaikutusaluejärjestelmä. (Summary: The systems of functional centers and areas in Finland). *Publications of the National Planning Office, Series A: 19*. Helsinki. 134 pp. + app.
- Luttrell, W. F. (1962). *Factory Location and Industrial Movement: A Study of Recent Experience in Great Britain. Volume 1*. 422 pp. National Institute of Economic and Social Research. London.
- Mäenpää, Ilmo, Tero Karinen and Mikko Viitanen (1981). Hyödykkeiden energiasisältö. *Kauppa- ja teollisuusministeriön energiaosasto* B 21. 89 pp.
- Mäkelä, Vilho and Markku Virtanen (1986). Mikkelin läänin rahavirrat, Rahoitustilinpitoanalyysi vuosilta 1980—1983. *Helsingin kauppakorkeakoulu* M-13. 65 pp.
- Malecki, Edward J. (1983). Technology and Regional Development: A Survey. *International Regional Science Review* 8, 89—125.
- Malinen, Pentti (1985). Suomalaisen tietoyhteiskun-

- nan alueelliset piirteet. *Aluesuunnittelu* 14: 1, 6—11.
- Massey, Doreen (1979). In what sense a regional problem? *Regional Studies* 13, 233—243.
- Massey, Doreen (1984). *Spatial Division of Labour*. 339 pp. Macmillan Education Ltd, London and Basingstoke.
- Mella, Ilkka and Pentti Vuorinen (1984). Datateknologien regionala spridning i Norden. Del I. *Nordiska Ministerrådets Regionalpolitiska Basprojektet*. BAS 5/84. 82 pp. Helsingfors.
- Miller, G. Tyler, Jr. (1979). *Living in the Environment*. 630 pp. Wadsworth, Belmont, California.
- Mitchell, Bruce (1979). *Geography and resource analysis*. 399 pp. Longman Group Limited, London.
- Myrdal, Gunnar M. (1957). *Economic Theory and Underdeveloped Regions*. 168 pp. Duckworth, London.
- Newcombe, Ken (1977). Nutrient Flow in a Major Urban Settlement: Hong Kong. *Human Ecology* 5, 179—208.
- Newcombe, Ken, Jetse D. Kalma and Alan R. Aston (1978). The Metabolism of a City: The Case of Hong Kong. *Ambio* 7: 1, 3—15.
- Niinistö, Kauko V. (1974). *Kymenlaakson alueellinen kehitys vuosina 1910—1970*. With summary: Regional Development in Kymenlaakso, 1910—1970. 287 pp. Iitin painopalvelu.
- Nijkamp, Peter (1984). A Multidimensional Analysis of Regional Infrastructure and Economic Development. In Andersson, Åke E., Walter Isard and Tönu Puu (eds.): *Regional and Industrial Development Theories, Models and Empirical Evidence*, 267—293. Elsevier Science Publishers B.V., Amsterdam.
- Okko, Paavo (1985). Aluepolitiikan kehittämistarve talouden sopeutusmishaasteiden näkökulmasta. In Aluepolitiikan muuttuva toimintaympäristö, 161—175. *Sisäasiainministeriö, aluepoliittinen osasto. Aluepoliittisia artikkeleita 2/1985*.
- O'Riordan, Timothy (1971). *Perspectives on Resource Management*. 183 pp. Pion, London.
- Palomäki, Mauri (1968). On the Concept and Delimitation of the Present-Day Provinces of Finland. *Acta Geographical* 20, 279—295 + map.
- Palomäki, Mauri (1972). Kaupungistumisprosessin vaikutus taloudellisten ydinalueiden syntymiseen ja siirtymiseen. *Proceedings of the Vaasa School of Economics. Research Papers* 10. 23 pp.
- Palomäki, Mauri (1980). Industrial Development and Regional Standards of Living in Finland. In Walker, David F. (ed.): *Planning Industrial Development*, 189—213. John Wiley and Sons Ltd, The Pitman Press, Bath, Avon.
- Palomäki, Mauri (1982). Kaupunkikäsitteen muuttuminen 1970-luvulla. In Malinen, Pentti et al. (eds.): *Aluesuunnittelupäivät 1982*, 5—16. *Suunnittelu- ja maantieteen yhdistyksen julkaisuja* 8.
- Paterson, J. H. (1978). *Land, Work and Resources*. 261 pp. Edward Arnold Ltd, London.
- Peltonen, Arvo (1982a). Suomen kaupunkijärjestelmän kasvu — ”tapuliteoreettinen” näkökulma. In Malinen, Pentti et al. (1982): *Aluesuunnittelupäivät 1982*, 17—33. *Suunnittelu- ja maantieteen yhdistyksen julkaisuja* 8.
- Peltonen, Arvo (1982b). Suomen kaupunkijärjestelmän kasvu 1815—1970. Teollistumisen vaikutuksista periferisen maan kaupungistumiseen. *Bidrag till kännedom av Finlands natur och folk* H 128. 219 pp.
- Perloff, Harvey S., Edgar S. Dunn Jr., Eric E. Lampard and Richard F. Muth (1960). *Regions, Resources, and Economic Growth*. The John Hopkins Press, Baltimore.
- Perroux, Francois (1970). Note on the Concept of ”Growth Poles”. Translated from Note sur la notion de pole croissance (1955). In McKee, D. L., R. D. Dean and W. H. Leachy (eds.): *Regional Economics*, 93—103. The Free Press, New York.
- Pohjois-Karjalan lääninhallitus (1978). *Pohjois-Karjalan läänin alueellinen kehittämissuunnitelma*. 166 p. Joensuu.
- Pohjois-Karjalan seutukaavaliitto (1982a). Pohjois-Karjalan vaikutusalue tutkimus 1982. *Pohjois-Karjalan seutukaavaliitto A* 36. Joensuu. 73 pp. + app.
- Pohjois-Karjalan seutukaavaliitto (1982b). Yrityskisteri. Joensuu. Mimeo.
- Pohjois-Karjalan seutukaavaliitto (1984a). Pohjois-Karjalan energiasuunnitelma 1985—2010. *Pohjois-Karjalan seutukaavaliitto A* 39. Joensuu. 65 pp. + app.
- Pohjois-Karjalan seutukaavaliitto (1984b). Kokonaisu-suunnitelma 1984—2010. Rakenneosa. Luonnos 15. 5. 1984. Joensuu. Mimeo.
- Pohjois-Karjalan seutukaavaliitto (1985). Pohjois-Karjalan teollisuuden rakenne ja teollisuustyöpaikat vuosina 1978—1984. *Pohjois-Karjalan seutukaavaliitto A* 41. Joensuu. 50 pp. + app.
- Pohjois-Karjala toimikunnan mietintö. *Komiteanmietintö* 1980: 49. Helsinki 1980.
- Pred, Alan (1965). Industrialization, Initial Advantage, and American Metropolitan Growth. *Geographical Review* 55, 158—185.
- Pulliainen, Kyösti and Heikki Eskelinen (1978). Pohjois-Karjala 2017: Näkökulmia tulevaisuuteen. *University of Joensuu, Publications of Karelian Institute* 26. 85 pp.
- Radnitzky, Gerard, (1970). *Contemporary schools of metascience*. 200 pp. Akademiförlaget, Göteborg.
- Rasmussen, Kjeld and Anette Reenberg (1980). Ecological human geography — some considerations of concepts and methods. *Geografisk Tidsskrift* 80, 81—88.
- Raumolin, Jussi (1982). The Relationship of Forest Sector to Rural Development. *University of Oulu, the Research Institute of Northern Finland* 24. 64 pp.
- Regional accounting 1960/1970. *Central Statistical Office of Finland. Statistical Surveys*. 53. 170 pp. Helsinki 1975.
- Regional accounting 1976/1978. *Central Statistical*

- Office of Finland. Statistical surveys* 69. 222 pp. Helsinki 1982.
- Regional accounting 1980. *Central Statistical Office of Finland. Statistical surveys* 76. 120 pp. Helsinki 1984.
- Regional utveckling i Norden* (1982). *Årsrapport 1981*. Nordiska ämbetsmannakommitten för regionalpolitik. Basprojektet. 150 pp. + app. Helsinki.
- Regional utveckling i Norden (1984). Årsrapport 1983/1984*. Nordiska Ministerrådet, Regionalpolitiska Basprojektet. 111 pp. + app. Helsinki.
- Resource accounts (1981). *Central Bureau of Statistics. Statistiske analyser* 46. 198 pp. Oslo.
- Resursflöden i svensk jord- och skogsbruk 1956 och 1972 med tonvikt på energiströmmar. *Lantbruks-högskolan. Institutionen för ekonomi och statistik* 64. 127 pp. och bilagorna 3—12. Uppsala.
- Richardson, Harry W. (1977). *Regional Growth Theory*. 264 pp. The Macmillan Press, London and Basingstoke.
- Rothwell, Roy (1982). The Role of Technology in Industrial Change: Implications for Regional Policy. *Regional Studies* 16: 5, 361—369.
- Saloheimo, Veijo (1977). Maankäyttö perinnäisen maatalouden muutoksissa. *University of Joensuu, Publications of Karelian Institute* 28. 32 pp.
- Sant, Morgan (1982). *Applied Geography*. Practice, Problems and Prospects. 152 pp. Longman, London and New York.
- Schumpeter, Joseph A. (1934). The Theory of Economic Development. Translated by Redvers Opie. Fourth Printing 1951. *Harvard Economic Studies XLVI*. 255 pp.
- Segerstahl, Boris (1981). Systeemianalyysin mallijärjestelmä. In Melkas, J. (ed.): Seminar on Lapland, part IV, 94—102. *University of Oulu. Research Institute of Northern Finland C* 33.
- Seppälä, Heikki, Jari Kuuluvainen ja Risto Seppälä (1980): Suomen metsäsektori tienhaarassa. *Folia Forestalia* 434. 122 pp.
- Simmons, I. G. (1974). *The Ecology of Natural Resources*. 424 pp. Edward Arnold Ltd, London.
- Smith, David M. (1981). *Industrial Location*. An Economic Geographical Analysis. 492 pp. John Wiley and Sons Ltd, New York.
- Snickars, Folke, Å. E. Andersson and M. Albegov (1982). Regional development modeling — theory and practice. In Albegov, Murat, Åke E. Andersson and Folke Snickars (eds.): *Regional Development Modeling: Theory and Practice*, 3—25. North Holland Publishing Company, Amsterdam.
- Standard Industrial Classification (SIC) (1972). *Central Statistical Office of Finland. Handbooks* 4. Helsinki.
- Stöhr, Walter B. (1986). Territorial Innovation Complexes. *IIR — Discussion Papers* 28. Wien. 38 pp.
- Stöhr, Walter B. and R. D. Fraser Taylor (eds.) (1981). *Development from Above for Below?* 488 pp. John Wiley and Sons Ltd, New York.
- Stöhr, Walter B. (1981). Structural Characteristics of Peripheral Areas: The Relevance of the Stock-in-Trade Variables of Regional Science. *Papers of the Regional Science Association* 49, 71—84.
- Strahler, Arthur N. and Alan H. Strahler (1978). *Modern Physical Geography*. 502 pp. John Wiley and Sons Ltd, New York.
- STV = *Suomen tilastollinen vuosikirja* (Statistical Yearbook of Finland). Central Statistical Office of Finland. Helsinki.
- Suzuki, Y., H. Ishitani and K. Shoji (1976). An Integrated Regional Planning Model of the Kinki Area. In Hans Knop (ed.): *A Computer Assisted Approach to Regional Development*, 7—49. *IASA CP-75-10*. Luxemburg.
- SVT = *Suomen virallinen tilasto* (Official Statistics of Finland). Central Statistical Office of Finland. (National Board of Agriculture and The Finnish Forest Research Institute). Helsinki.
- Talman, Paavo (1978). Areal livestock combinations on Finnish farms. *Fennia* 157, 155—170.
- Taloudellinen suunnittelukeskus (1981). *Suomi 1995 kansatalouden kehittämisperusta*. 248 pp. Taloudellinen suunnittelukeskus. Helsinki.
- Tervo, Hannu (1983). Tuotantotoimintaan suunnatun aluepolitiikan työllistävä vaikutus kehitysalueilla 1966—1980. *Jyväskylän yliopisto, taloustieteen laitos, Keski-Suomen taloudellinen tutkimuskeskus* 57/1983. 208 pp.
- Thomas, Morgan D. (1972). Growth Pole Theory: An Examination of Some of its Basic Concepts. In Hansen, Niles M. (ed.): *Growth Centers in Regional Economic Development*, 50—81. The Free Press, New York.
- von Thünen, Johann Heinrich (1966). *Der Isolierte Staat in Beziehung auf Landwirtschaft und Nationalökonomie*. Hamburg 1826. Edited by Peter Hall and translated by Carla M. Wartenberg: von Thünen's Isolated State. 304 pp. Pergamon Press Ltd, Oxford.
- Törnqvist, Gunnar (1978). Swedish industry as a spatial system. In Hamilton, F. E. Ian (ed.): *Contemporary Industrialization*. Spatial analysis and regional development, 86—109. Longman, London and New York.
- Tykkyläinen, Markku (1984). Luonnonvaratilinpidon rakenteesta ja käyttömahdollisuuksista. In *Luonnonvarojen tilinpito*, 14—21. Maa- ja metsätalousministeriö. Luonnonvarainneuvosto.
- Tykkyläinen, Markku (1987a). Teollisuuden työvoimamuutokset 1980-luvun alkupuoliskolla Suomessa. *Terra* 99, 49—56.
- Tykkyläinen, Markku (1987b). Teollisuuden työllistävyys 1980-luvulla. — Mikkeliin läänin asema valtakunnallisessa kehityksessä. *Helsingin kaupporkeakoulu M-18*. 26 pp. + app.
- Tykkyläinen, Markku (1987c). Aloittavat pienyritykset maaseudulla. New small firms in rural areas. *Helsingin kaupporkeakoulu D-90*. 46 pp.
- Uudenmaan kuntien kehityserot (1984). Uudenmaan maakuntaliitto ry. 59 pp. Helsinki. Mimeo.
- Varjo, Uuno (1976). Arable farming in Finland; types and economics. *Publicationes Instituti Geographici*

- Universitatis Ouluensis* 57. 103 pp.
- Varjo, Uuno (1980). On the location of Agriculture in Finland. *Nordia* 14: 1, 1—15.
- Wärneryd, Olof (1975). Interregionala beroenden. In Periferi og Sentrum i historien, 29—57. *Studier i historisk metode X*. Universitetsforlaget, Oslo.
- Vartiainen, Perttu (1979). Muuttoliike alueellisen kehityksen mekanismina Pohjois-Karjalassa 1960-luvulla ja 1970-luvun alkupuolella. *University of Joensuu, Publications of Social and Regional Sciences* 12. 112 pp + app.
- Watts, H. D. (1981). *The Branch Plant Economy: A Study of External Control*. 104 pp. Longman Group Limited, Essex, UK.
- Weber, Alfred (1929). *Theory of the Location of Industries*. Translated by C. J. Friedrich from über den Standort der Industrien (1909). 256 pp. The University of Chicago Press, Chicago.
- Whitaker, J. Russell (1954). The Geography of Resources. In James, Perston E. and Clarence F. Jones (eds.): *American Geography: Inventory and Prospects*, 226—231. Syracuse University Press, Syracuse.
- Victor, Peter A. (1972). *Pollution: Economy and Environment*. 247 pp. George Allen and Unwin Ltd, London.
- Wilson, Alan (1973). Towards systems models for water control resource management. *Journal of Environmental Management* 1, 65—81.
- Virkkala, Seija (1983). Teollisuusyritysten alueellinen organisaatio Suomessa. *Yhteiskuntasuunnittelu* 4/1983, 3—11.
- Volk, Raija and Heikki Eskelinen (1982). Free Trade between Finland and the EEC: Sectoral and Regional Effects in the 1970's. In Finnish with English summary. *Pellervo Economic Research Institute* 2. 91 pp. + app.
- Wolman, Abel (1965). The Metabolism of Cities. *Scientific American*, 213: 3, 179—190.
- Wood, P. A. (1969). Industrial Location and Linkage. *Area* 2, 32—39.
- Vuorinen, Pentti (1985). Uusi teknologia ja alueellinen kehitys. In Aluepolitiikan muuttuva toimintaympäristö, 29—73. *Sisäasiainministeriö, Aluepoliittinen osasto. Aluepoliittisia artikkeleita* 2/1985. Helsinki.
- Yli-Jokipii, Pentti (1982). Trends in Finnish geography in 1920—1979 in the light of the journals of the period. *Fennia* 160, 95—193.
- Young, A. J. (1973). Rural and evaluation. In Dawson, J. A. and J. D. Doornkamp (eds.): *Evaluating the Human Environment*, 5—33. Edward Arnold Ltd, London.
- YTV (1983). Pääkaupunkiseutu talousalueena. *Pääkaupunkiseudun yhteistyövaltuuskunta. Pääkaupunkiseudun julkaisusarja A* 1983/7. 136 pp. Helsinki.
- Zimmermann, Erich W. (1951). *World Resources and Industries*. Revised Edition. 832 pp. Harper and Brothers, Publishers, New York.

APPENDIX I. An excursion into the mathematics of the models used.

Materials flow model: an example

Let us assume that an economy has two industries A and B, which use natural resources, produce commodities and generate waste. The following commodity flows between these industries, measured in monetary terms (FIM), may be denoted in an input-output table:

$$\begin{matrix} & \text{A} & \text{B} \\ \text{A} & \begin{bmatrix} 1 & 6 \end{bmatrix} \\ \text{B} & \begin{bmatrix} 4 & 0 \end{bmatrix} \end{matrix}$$

This indicates that industry A uses one unit (FIM) of input from its own production and 4 units from industry B, while industry B uses 6 units of the production of industry A.

Let the vector *y* describe the final product demand in monetary terms (FIM). This can be divided into two components, that going to exports and that intended for consumption locally. The two industries will produce final products in the following manner (in FIM):

$$\begin{matrix} y_e & y_{c+i} & & y \\ \text{A} & \begin{bmatrix} 0 \\ 1 \end{bmatrix} & , \text{ thus} & \begin{bmatrix} 1 \\ 1 \end{bmatrix} \\ \text{B} & \begin{bmatrix} 6 \\ 0 \end{bmatrix} & , \text{ thus} & \begin{bmatrix} 1 \\ 6 \end{bmatrix} \end{matrix}$$

The above distribution of the vector *y* shows that only industry B exports its products, while the final production of industry A goes entirely to supply the local market.

Let vector *x* describe total outputs (in FIM). The figures obtained are:

$$\begin{matrix} x \\ \text{A} & \begin{bmatrix} 8 \\ 8 \end{bmatrix} \\ \text{B} & \begin{bmatrix} 10 \\ 8 \end{bmatrix} \end{matrix}$$

Let us assume that industries A and B process two natural resources R1 and R2, in addition to which industry B exports 3 units of resource R2 directly. When then obtain:

$$\begin{matrix} & \text{A} & \text{B} \\ \text{R1} & \begin{bmatrix} 20 & 0 \end{bmatrix} & \text{exported} & \begin{bmatrix} 0 & 0 \end{bmatrix} \\ \text{R2} & \begin{bmatrix} 0 & 6 \end{bmatrix} & \text{directly} & \begin{bmatrix} 0 & 3 \end{bmatrix} \end{matrix}$$

Industries A and B generate final products by weight (metric tons) as follows:

$$\begin{matrix} \text{A} & \begin{bmatrix} 10 \\ 8 \end{bmatrix} \\ \text{B} & \begin{bmatrix} 8 \\ 3 \end{bmatrix} \end{matrix}$$

And waste correspondingly (tonnes):

$$\begin{matrix} \text{A} & \begin{bmatrix} 8 \\ 3 \end{bmatrix} \\ \text{B} & \begin{bmatrix} 3 \\ 8 \end{bmatrix} \end{matrix}$$

The above data can now be used to form matrices in the manner employed in section "Modelling ...".

The input coefficient matrix A is:

$$A = \begin{bmatrix} 1/8 & 6/10 \\ 4/8 & 0/10 \end{bmatrix} \text{ or } \begin{bmatrix} .125 & .6 \\ .5 & 0 \end{bmatrix}$$

The units of the resource utilization matrix (R) are tonnes/FIM, depicting resource utilization per unit of total output:

$$R = \begin{bmatrix} 20/8 & 0/10 \\ 0/8 & 6/10 \end{bmatrix} \text{ or } \begin{bmatrix} 2.5 & 0 \\ 0 & .6 \end{bmatrix}$$

Thus matrix R describes the amounts of natural resources R1 and R2 used by industries A and B per unit of their total outputs.

The direct coefficient is obtained in the form of matrix R', which describes the amounts exported directly by the two industries:

$$R' = \begin{bmatrix} 0/1 & 0/6 \\ 0/1 & 3/6 \end{bmatrix} \text{ or } \begin{bmatrix} 0 & 0 \\ 0 & .5 \end{bmatrix}$$

This indicates the amounts of natural resources delivered by the industries directly to meet final demand per unit of final product.

$$\begin{matrix} \text{Matrix W} \\ = \begin{bmatrix} 8/8 & 3/10 \end{bmatrix} \text{ or } \begin{bmatrix} 1 & .3 \end{bmatrix} \end{matrix}$$

depicts the generation of waste (in metric tons) per unit of total returns (in FIM).

The amount of final products (in tonnes) per unit of final demand is obtained from the matrix

$$G = \begin{bmatrix} 10/1 & 0 \\ 0 & 8/6 \end{bmatrix} \text{ or } \begin{bmatrix} 2.5 & 0 \\ 0 & .6 \end{bmatrix}$$

The inverse matrix is

$$(I-A)^{-1} = \begin{bmatrix} 1.73913 & 1.04348 \\ .869565 & 1.52174 \end{bmatrix}$$

This inverse matrix indicates how much production is required in all in each industry to achieve one unit of final product. Thus

$$(I-A)^{-1} y = x$$

which can be shown to hold good by means of an example calculation. According to the above equation the total output for industry A are $1.74 \times 1 + 1.04 \times 6 = 8$, i.e. to satisfy every 1 FIM worth of final demand in industry A one requires 1.74 FIM of total output in industry A, while to satisfy a 6 FIM final demand in industry B one requires 6.26 FIM of total output in industry A. This means a total output in industry A of 8 FIM, which was our initial assumption. Correspondingly, the manufacturing of commodities to give total output of 10 FIM in industry B entails final demand contributions of .87 FIM from industry A and 9.13 from industry B. Thus the basic equation for our input-output model holds good.

Let us now look at the expression

$$R(I-A)^{-1}$$

contained in equations 1, 2, 5, 10, 11 and 15. This constructs a matrix product from the resource utilization matrix R and the inverse matrix.

Using the above data as an example:

$$R(I-A)^{-1} = \begin{bmatrix} 4.35 & 2.61 \\ .52 & .91 \end{bmatrix}$$

in which the rows indicate the natural resources R1 and R2 and the columns industries A and B. The coefficient shows the amounts of the resources detailed in the given row required in the economy as a whole to produce one unit of final product in the industry in question. This may be referred to as the resource requirement per final product. The unsummed product of the above equation and the final demand vector denotes the extent of the natural resources required to satisfy the final demand for the product of each industry at all stages in production. In the example, 4.35×1 tonnes of resource R1 is required for the final demand of industry A and $2.61 \times 6 = 15.66$ tonnes for those of industry B.

We notice now that although industry B does not use resource R1 as such in its production, it does have a certain requirement for it, mediated by intermediate products of industry A.

It can be shown that these amounts of resources used by the various industries (in each resource category separately) are equal to the amounts bound up in the final products.

$$R(I-A)^{-1}y = \begin{bmatrix} 20 \\ 6 \end{bmatrix} = R_x$$

which is equivalent to the resource utilization per industry R_x .

In such a case the amount of natural resources utilized in the whole economy, including those delivered directly without processing (matrix R') is

$$R(I-A)^{-1}y + R'y = \begin{bmatrix} 20 \\ 9 \end{bmatrix}$$

which is equal to the sum of the total of resources R1 and R2 in our initial assumptions.

It may now be shown that Equation 1 in section "Modelling . . ." holds good, i.e. that

$$R_x + R'y = R(I-A)^{-1}y + R'y$$

This implies that the amounts of natural resources utilized in an economy is equal to the amounts of resources embodied in final demand by the various resource categories. The right-hand side of this equation may be rewritten in the form (Equation 2):

$$R(I-A)^{-1}y + R'y = R''y$$

in which the matrix R'' is known as the total coefficient matrix. This indicates the amount of the resource detailed in a given line (in tonnes) required for one unit of final product (in FIM) in the industry denoted by the given column (including amounts exported directly without processing).

Equations 3 and 4 may be explained on the same principles as the resource utilization equations above, namely

$$W_x = 11 = W(I-A)^{-1}y$$

Let us, for simplicity, refer to the right-hand side of this equation as W'' , which using our data would be

$$W'' = [2 \quad 1.5]$$

This shows that the manufacture of final products of industry A to the value of 1 FIM generates a waste loading of 2 tonnes and the manufacture of final products of industry B to the same value a loading 1.5 tonnes. Comparison of these results with the waste generation figures for the industries leads us to conclude that waste loading by industry B is relatively greater when calculated per unit of final product than per total output in relation to industry A. This is due to the multiplier effect of the waste loading contribution of the intermediate products purchased by industry B from industry A (i.e. the effects of industry A on industry B in this respect are greater than those of B on A). The multiplier effects thus lead to a redistribution of waste loading between the two, the total waste loading (and totals in individual load categories) will naturally remain the same, however.

Equation 5 describes the equilibrium achieved in the flows of materials (natural resources = waste + commodities). In our example the left-hand side of the equation gains the value

$$\Sigma R(I-A)^{-1}y + \Sigma R'y = 26 + 3 = 29$$

i.e. a total of 29 tonnes resources are used in the economy. This is the sum of the figures for resources R1 and R2.

The right-hand side gains the values

$$\Sigma W(I-A)^{-1}y + \Sigma Gy = 11 + 18 = 29$$

i.e. waste plus the total of commodities is 29 tn. Thus the amount of materials (resources) entering the economy is rendered equal to the amount leaving it (waste + commodities). The commodities and waste cannot here be accounted to particular resource categories, and thus only the totals may be shown to be equal (Equation 5). The resources can in turn be divided into local and imported resources, of course, as was done in the case of the data from Northern Karelia. The above equation does not take account of imported intermediate products other than natural resources, however, although they could if necessary be placed on the left-hand side in Equation 5.

In Equations 6 and 7 resource utilization and waste generation per unit of final product are calculated in relation to the amounts of final products in each industry by transforming vector y into a diagonal matrix:

$$D = R''\hat{y} = \begin{bmatrix} 4.35 & 15.66 \\ .52 & 8.46 \end{bmatrix}$$

$$H = W''\hat{y} = [2 \quad 9]$$

The first row of this matrix indicates the amount of resource R1 in tonnes bound up in the final demand for the products of industries A and B at all stages in production. Correspondingly, row 2 indicates the amounts of resource R2 bound up in the same final

demand. Waste loading attached to the final demand divided up by industry shows the amount of waste generated in the manufacture of the final products of industry A, taking all stages in production into account, to be 2 tonnes and the corresponding figure for industry B to be 9 tonnes. Thus the waste generated in the economy is largely due to the final demand for the products of industry B, even though more is actually generated by industry A (8 tonnes).

Resource use attached in the final demand also deviates markedly from resource use by industries, especially as far as resource R1 is concerned. This is used as a direct input only by industry A (20 tonnes), by virtue of the multiplier effects in the economy the majority of this is bound in the final demand for products of industry B (15.66 tonnes).

In Equation 8 the amounts of resources used and waste generated are first distributed by industry (matrices T and V), after which they are aggregated into appropriate classes by means of a sum operator (Equation 8). (Sum operators does not mean that the total sums of the matrices are calculated, but that the indices to the operators are omitted as being unnecessary for the reader).

With the data of the above example:

$$V = v(i,j) = \begin{bmatrix} 8 & 3 \end{bmatrix}$$

$$T = t(i,j) = \begin{bmatrix} 20 & 0 \\ 0 & 6 \end{bmatrix} + \begin{bmatrix} 0 & 0 \\ 0 & 3 \end{bmatrix} = \begin{bmatrix} 20 & 0 \\ 0 & 9 \end{bmatrix}$$

Indices for the intensity of resource use in each industry A and B can now be calculated from Equation (8)

for A $p_1 = 8/20 = .4$
 for B $p_1 = 3/9 = .33$

Thus the ratio of waste generated to resources used is .4 for industry A and .33 for industry B.

The corresponding distributions of resources and waste attached in the final demand are obtained for the two industries as follows:

$$H = h(i,j) = \begin{bmatrix} 2 & 9 \end{bmatrix}$$

$$D = d(i,j) = \begin{bmatrix} 4.35 & 15.66 \\ .52 & 8.46 \end{bmatrix}$$

Summing the resource categories of matrix D, we obtain resource use intensity indices per unit of final product as follows:

for A $p_2 = 2/4.87 = .41$
 for B $p_2 = 9/24.12 = .37$

This implies that the ratio of waste generated in the manufacture of the final products of industry A to the resources used is .41 (i.e. taking into account the multiplier effects within the economy), while the corresponding figure for the final products of industry B is .37. The intensity figures per unit of final product thus differ from those per industry, since they indicate the efficiency of the whole chain of manufacture involved in the generation of these products. The total amounts of resources used and waste produced are

naturally the same in both calculations, but they are distributed between the industries on different grounds.

In Equations 10—13 final demand is divided into two components, export demand and local demand. These equations may be used to calculate the amounts of natural resources required to satisfy the export demand and local demand respectively. In our example:

$$r_e = (R(I-A)^{-1} + R'_e)y_e = \begin{bmatrix} 15.66 \\ 8.46 \end{bmatrix}$$

$$r_{c+i} = (R(I-A)^{-1} + R'_{c+i})y_{c+i} = \begin{bmatrix} 4.35 \\ .52 \end{bmatrix}$$

The proportion of resource utilization accounted for by exports may now be calculated from the above absolute figures, leading to the conclusion that 78% of resource R1 ends up by being exported and 94% of R2.

A corresponding calculation may be performed for waste

$$w_e = W'y_e = 9$$

$$W_{c+i} = W'y_{c+i} = 2$$

implying that 82% of waste generation may be attributed to exports and 18% to the meeting of local demand. (Since in this case only industry B exports any of its products, the resource use and waste generation figures for the export demand are equal to those figures for total final demand for industry B, while in industry A those for local demand are equals to those totals for industry A. This is of course only a feature of this particular set of imaginary data and would only hold good in special cases of this kind.)

In Equation 14 resource use arising from exports is divided between the industries in the form of matrix K, after which the individual resource use figures (in tonnes) are calculated per unit of total output in each industry. The resulting measure, expressed in metric tons per FIM denotes the resources used in manufacturing products for export in each industry in relation to that industry's total output in our example:

$$K = \begin{bmatrix} 0 & 15.66 \\ 0 & 8.46 \end{bmatrix}$$

$$r^*(i,j) = \begin{bmatrix} 0/8 & 15.66/10 \\ 0/8 & 8.46/10 \end{bmatrix}$$

i.e. exportation of resource R1 in industry B is 1,566 tonnes for every unit of total output (FIM) and exportation of R2 correspondingly .85 tonnes. Since industry A does not have any export trade of its own, its resource exportation figure per unit of total returns is zero.

It should be noted here that only industry A is a user of resource R1 (20 tonnes) but this amount is then transmitted to the account of industry B via the intermediate products used in the latter's exports, so that the 1,566 tonnes of R1 used in exports per unit of total output recorded for industry B is in effect entirely derived from industry A.

Equation 15 calculates the waste loading entailed in

manufacturing products for export in relation to total returns in the industry concerned.

$$Z = W''\hat{y}_c = [0 \quad 9]$$

$$w^*(i,j) = z(i,j)/x(j) = [0/8 \quad 9/10]$$

i.e. the generation of waste associated with exports in industry B is 0.9 tonnes per unit of total output.

These calculations enable the resource use and waste generation entailed in the export trade to be related to the size of the industry concerned. Since total outputs are used to establish this relation and not final demand, the amounts of resources and waste are in effect being compared with total production in the industry concerned. The influence of local demand on resource use and waste generation can then be calculated analogously, using the appropriate local demand data (bearing the subscript *c+i* instead of *e*).

The evaluation model: an example

The evaluation model (linear programming model + simulation model) is presented in Equations 16–30 in section "Structure of the model". We shall look in more detail here at Equations 20–22.

Equation 20 describes total output in electricity and heat generation *x(s)*, in the form

$$x(s) = e(a) + e(t) + e(w)x(w) + e(s)x(s),$$

in which *e(a)* = demand for intermediate products of electricity and heat supplies in agriculture, forestry, the service sector and direct consumption, *e(t)* = electricity and heat input requirements of the various branches of industry, calculated from the simulation model, *e(w)* = coefficient representing electricity and heat input requirements per unit of total output from water supplies, *x(w)* = total output from water supplies, *e(s)* = input requirement in the electricity and heat generation industry from its own sector due to the demand for intermediate products, in order to achieve the total output indicated.

The total output from water supplies is obtained from Equation 21:

$$x(w) = v(a) + v(t) + v(s)x(s),$$

where *v(a)* = input of intermediate products from water supplies due to demand in agriculture, forestry, services and domestic consumption, *v(t)* = requirement for intermediate products of water supplies in the branches of industry included in the simulation model, and *v(s)* = requirement for intermediate products of water supplies in electricity and heat generation per unit of total output in that sector. *x(s)* = total output in electricity and heat generation.

Equation 20 may be solved by the insertion of Equa-

tion 21. The total returns in electricity and heat generation are obtained from Equation 22:

$$x(s) = (e(a) + e(t) + e(w)v(a) + e(w)v(t)) / (1 - e(w)v(s) - e(s))$$

This in turn is required for the calculation of the total output in water supplies by means of Equation 21.

Solution of these equations may be illustrated by the following example. Let us assume that agriculture, forestry, the service sector and domestic consumption place a demand of 200 FIM on the electricity and heat generating sector, *e(a)* = 200 FIM, the demand for intermediate products in industry totals 300 FIM, *e(t)* = 300 FIM, the demand for intermediate products in water supplies amounts to .14 of total output in this sector, *e(w)x(w)* = .14*x(w)*, and the electricity and heat generation sector requires a further input of its own to the extent of .34 of the demand for its total output in order to achieve the total output indicated for that sector, *e(s)x(s)* = .34*x(s)*. Correspondingly, we assume a water requirement of 40 FIM in agriculture, forestry, the service sector and domestic consumption, *v(a)* = 40, an industrial requirement of 50 FIM *v(t)* = 50 and an intermediate product input from water supplies in electricity and heat generation which is .015 times the total output in that sector, *v(s)x(s)* = .015*x(s)*.

The total output in electricity and heat generation may now be resolved using Equation 22:

$$x(s) = (200 + 300 + .14*40 + .14*50) / (1 - .14*.015 - .34)$$

$$x(s) = 779.15$$

and that in water supplies using Equation 21:

$$x(w) = 40 + 50 + .015*779.15$$

$$x(w) = 101.687$$

The results may be checked by dividing up the total output in the electricity and water supply sectors as follows:

<i>e(a)</i>	=	200
<i>e(t)</i>	=	300
Water supplies	.14*101.687	= 14.24
Electricity and heat	.34*779.2	= 264.91
<i>x(s)</i>	=	779.15

The contributions to total output in water supplies are:

<i>v(a)</i>	=	40
<i>v(t)</i>	=	50
Electricity and heat	.015*779.2	= 11.687
<i>x(w)</i>	=	101.687

These results are the same as with Equations 21 and 22.

APPENDIX II. Classification of natural resources and waste.

Natural resources are classified into 27 categories and waste into 36, each with local and imported resources distinguished separately. Totals marked with (+) include imports from other parts of Finland or from abroad. * = category omitted from the materials flow model in order to avoid double accounting.

Resources:

Water
 Water intake
 Wood
 Industrial large-sized timber (+)
 Industrial cordwood (+)
 * Wood chips and particles
 * Wood residues from industry
 Fuelwood
 Protein/Food and animal fodder
 Fish
 Cereals (+)
 Hay, mixed grain, silage, green fodder
 Milk (+)
 Meat
 Other agricultural products
 Uncultivated and wild products
 Minerals
 Ores
 Gravel, and
 Clay
 Peat mold
 Peat as fuel
 Energy (energy content in TJ)
 Fuel oil (+)
 Petrol (+)
 Coal and coke (+)
 Gas (+)
 Peat as fuel
 Fuelwood
 Bark, sawdust and residues as fuel
 Black liquor
 Hydroelectric power

Material resources

Non-
renewable



Waste:

Solid

- Tissues and organs
 - Bones
 - Entrails, meat and fat
 - Blood
 - Milk, whey
 - Bran, meal, cereals
 - Hides
 - Manure
 - Injured products, miscellaneous organic waste
 - Organic sludge
 - Textiles, leather, fur
 - Paper and board
 - Wood residues
 - Slag
 - Chemical solvents
 - Washing materials
 - Paints, glues, saturation agents and pigments
 - Inorganic acids
 - Other chemicals
 - Rocky materials and sand
 - Concrete, ceramic and porcelain
 - Glass wool and similar fibres
 - Lubricants, wax
 - Working liquids and grinding waste
 - Iron and steel materials
 - Other metals, machines and equipments
 - Miscellaneous construction waste
 - Mixed and miscellaneous waste
 - Sewage sludge
- Water discharge
- Water discharge
- Emissions into air:
- Sulphur dioxide
 - Nitrogen oxides
 - Particles
 - Carbon monoxide (from vehicles only)
 - Hydrocarbon (from vehicles only)
 - Lead (from vehicles only)
-

APPENDIX III. Classification of industries in Northern Karelia.

Local resource-based industries

Primary production

1. Agriculture
2. Forestry
3. Fishing
4. Metal ore mining
5. Other mining

Resource processing

6. Meat preparing
7. Dairy products
8. Other food and animal fodder
10. Sawn timber
11. Other wood processing
12. Pulp and paperboard
15. Mineral products

Power and water

19. Power (= electricity and steam)
20. Water supply

Construction

21. Building construction
22. Road and land construction

Local resource-independent industries

Other industries

13. Printing and publishing

New industries

9. Clothing
14. Chemical products
16. Metal products
17. Machinery
18. Other manufacturing

Services

23. Wholesale and retail trade
 24. Restaurants and hotels
 25. Transport
 26. Finance and insurance
 27. Sanitary services etc.
 29. Social and related services
-

APPENDIX IV. Branches of industry, profitability, energy, water, labour and capital parameters and maximum constraints on production used in the linear programming and simulation model.

No.	SIC code	Industries	Net rate of returns	Power	Water	Labour personnel /1000 FIM	Capital	Max. output mill. FIM
		Industries of Northern Karelia	a(i)	e(i)	v(i)	t(i)	c(i)	x(i)
1	230	Metal ore mining	-.170	.111	.00029	.00760	3.105	556
2	290	Other mining	-.334	.013	.00000	.00200	2.349	377
3	311-2	Food processing	.050	.011	.00126	.00309	.424	18965
4	321	Textiles	.199	.021	.00025	.01117	1.053	2667
5	322	Clothing	.207	.006	.00011	.01304	.317	2719
6	323	Leather and leather pr.	.228	.011	.00000	.01027	.235	338
7	331	Wood prod. excl. furniture	.057	.031	.00040	.00466	1.682	6739
8	332	Furniture and fixtures	.265	.016	.00006	.00789	.560	1214
9	341	Paper and paper products	-.217	.001	.00012	.00575	3.683	16858
10	342	Printing and publishing	.225	.005	.00039	.00836	.564	4999
11	351	Industrial chemicals	.100	.062	.00019	.00139	.811	4163
12	355	Rubber products	.312	.042	.00229	.00562	1.377	509
13	356	Plastics	.139	.020	.00026	.01128	1.715	935
14	369	Non-metallic mineral pr.	.137	.021	.00053	.00782	.603	2321
15	371	Iron and steel industries	.078	.027	.00080	.01144	1.226	5047
16	381	Fabricated metal products	.243	.013	.00119	.00944	.651	3539
17	382	Machinery excl. electrical	.206	.013	.00023	.00527	.575	7570
18	383	Electrical machinery	-.005	.014	.00000	.00966	.493	3680
19	384	Vehicles	-.012	.013	.00033	.00779	1.055	5045
20	385	Instruments etc.	.321	.011	.00000	.00985	.653	405
21	390	Other manufact. industries	.331	.010	.00000	.00416	.450	532
s	410	Electricity and steam	.118	.337	.00015	.00342	1.457	
w	420	Water supply	.606	.138	.00000	.00446	.252	
Industries in Finland as a whole								
22	290	Other mining	.151	.044	.00000	.00688	1.827	377
23	311-2	Food processing	.078	.008	.00044	.00277	.456	18965
24	313	Beverages	.208	.020	.00020	.00402	1.754	1416
25	314	Tobacco	.207	.010	.00000	.00450	.978	304
26	321	Textiles	.075	.021	.00007	.00855	1.464	2667
27	322	Clothing	.175	.006	.00011	.01188	.396	2719
28	323	Leather and leather pr.	.093	.011	.00000	.00810	.755	338
29	324	Footwear	.138	.006	.00000	.01054	.552	621
30	331	Wood prod. excl. furniture	.032	.031	.00017	.00608	1.218	6739
31	332	Furniture and fixtures	.177	.016	.00000	.00946	.856	1214
32	341	Paper and paper products	-.076	.086	.00008	.00288	2.092	16858
33	342	Printing and publishing	.241	.006	.00016	.00624	.605	4999
34	351	Industrial chemicals	.029	.062	.00019	.00315	1.675	4163
35	352	Other chemical products	.235	.009	.00000	.00532	.952	1770
36	355	Rubber products	.082	.042	.00000	.00890	2.051	509
37	356	Plastics	.208	.021	.00026	.00704	.799	935
38	361	Pottery, china etc.	.246	.027	.00000	.01023	1.630	138
39	362	Glass and glass products	.118	.027	.00000	.00730	1.180	452
40	369	Non-metallic mineral pr.	.099	.031	.00040	.00631	1.678	2321
41	371	Iron and steel industries	-.009	.027	.00008	.00280	1.517	5047
42	372	Non-ferrous metal ind.	-.012	.049	.00007	.00236	.944	2144
43	381	Fabricated metal products	.172	.013	.00007	.00789	.819	3539
44	382	Machinery excl. electrical	.164	.013	.00013	.00762	.860	7570
45	383	Electrical machinery	.133	.014	.00000	.00788	1.031	3680
46	384	Vehicles	.132	.013	.00033	.00711	.698	5045
47	385	Instruments etc.	.181	.011	.00000	.01038	.546	402
48	390	Other manufact. industries	.214	.010	.00000	.00918	.503	532

